

RoHS

WWW.ADZLCONN.COM

TEL:0769-82285488

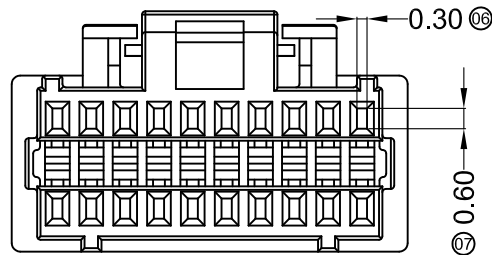
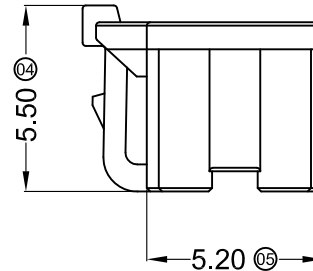
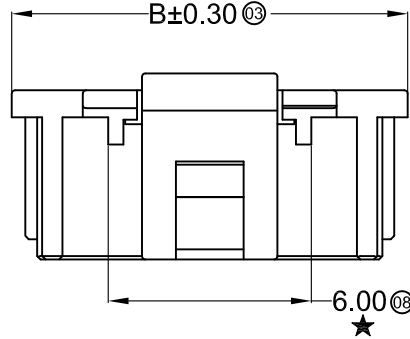
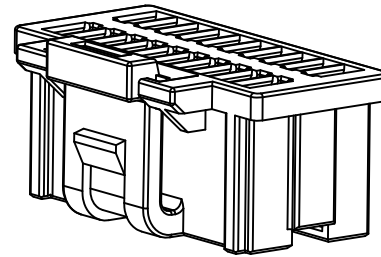
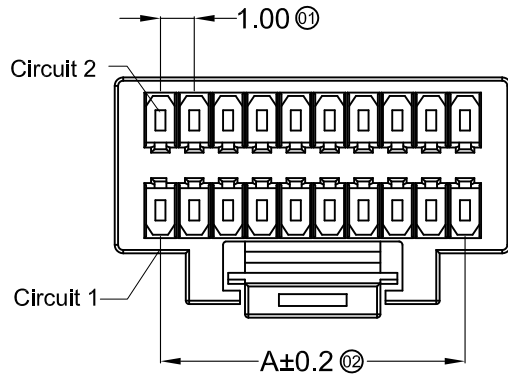

■ Specifications :

- Voltage rating: 50V AC / DC
- Current rating: 1A AC / DC
- Withstanding voltage: 250V AC/minute
- Temperature range: -25°C~+85°C
- Insulation resistance: ≥100MΩ
- Contact resistance: ≤20mΩ
- After environmental testing: ≤40mΩ

1018 H X-2\*XX X-N0 HF XX  
 (1) (2) (3) (4) (5) (6) (7) (8)

- (1) Series No.
- (2) Category: H-HSG
- (3) Welding Board Angle: Blank-ordinary
- (4) Row No.-Pin No.: 2\*XX-Double row
- (5) Plug the Pin & special No.
- (6) Material: N0-PA66 94V-0
- (7) HF-Halogen Free
- (8) Color: Blank-Natural color  
BK-black

Poles	Dimensions (mm)	
	A	B
2x10	9.00	11.70
2x12	11.00	13.70
2x15	14.00	16.70
2x20	19.00	21.70
2x25	24.00	26.70

1018H-2*XX-N0HF	Nylon 66 UL 94V-0 Natural	1018T	1018W
1018H-2*XX-N0HFBK	Nylon 66 UL 94V-0 Black	1018T	1018W
PART NO	Material	Suitable ADZL Terminal	Mates ADZL Wafer

DATE	OLD REV	NEW REV	ECN	DESCRIPTION	CHECK	APPROVAL	PROJECT
1							
2							
3							
4							

GENERAL TOLERANCE  
 .X ±0.30  
 .XX ±0.20  
 .XXX ±0.10

**ADZL** 东莞市思量连接器有限公司  
 DONGGUAN ADZL CONNECTORS CO.,LTD.

APPROVAL	CHECK	DRAWN	DATE
Ken	Wisely He	Allen	2017/11/25

PART NO.			
1018H-2*XX-N0HFXX			
TITLE			
1.00mm Crimp Style Connectors			
UNIT	SCALE	NUMBER	REV
MM	1:1	8	

**Specifications :**

- Voltage rating: 50V AC / DC
- Current rating: 1A AC / DC
- Withstanding voltage: 250V AC/minute
- Temperature range: -25°C~+85°C
- Insulation resistance: ≥100MΩ
- Contact resistance: ≤20mΩ
- After environmental testing: ≤40mΩ

1018 T X-P XX X-X  
① ②③④ ⑤ ⑥⑦

- ① Series Number
- ② Category: T-terminal
- ③ Shape: Blank-ordinary
- ④ Material: P-Phosphor bronze
- ⑤ Plating style: V01-ALL GOLD FIASH ;  
SN-30~50u" Ni;70~120u"Sn
- ⑥ Plating method: Blank-Stamping before plating
- ⑦ Mold No./Mark/Special No.

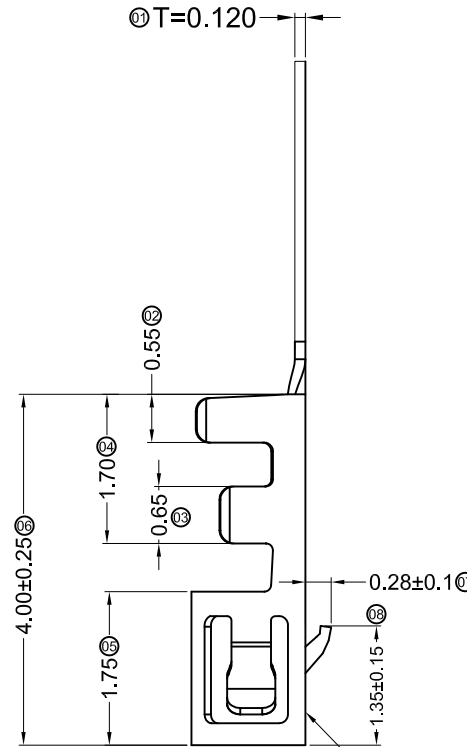
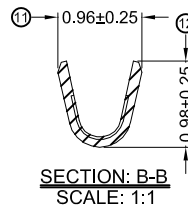
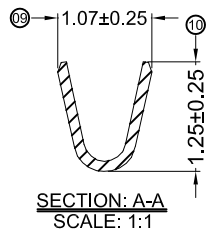
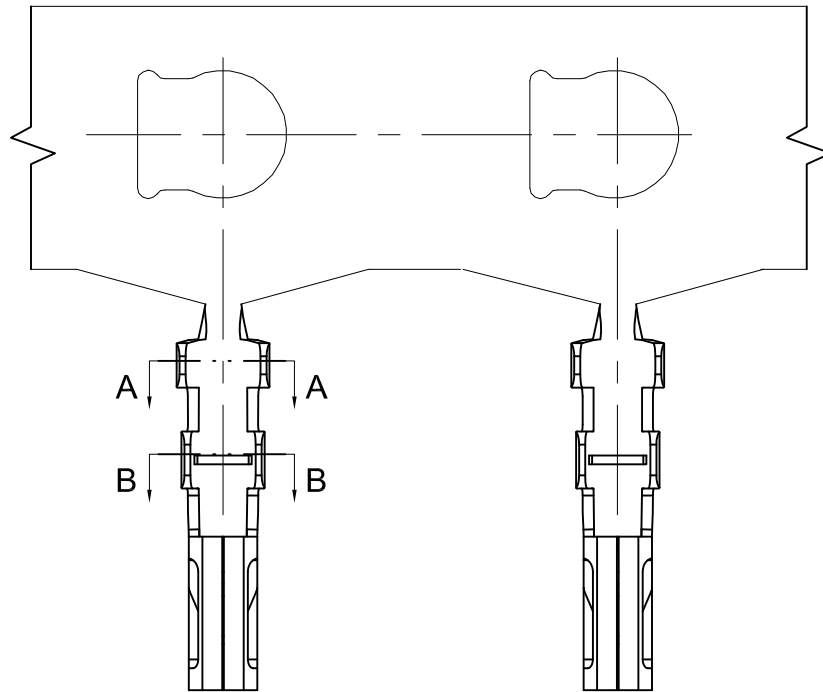

膜厚测点  
前端往下0.6mm

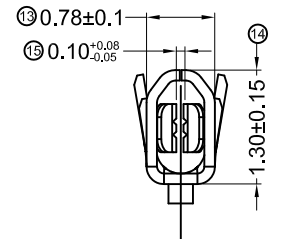

1018T-PSN	Phosphor Bronze	AWG#28-32	0.80mm(Max)	Stamping Before Plating:30~50u" Ni;70~120u"Sn	1018H
1018T-PV01				Stamping Before Pating:50u" Ni; Contact Gold FIASH	
PART NO	Material	Wire Range	Insulation O.D.	Finish	Used In ADZL Housing

GENERAL TOLERANCE	
.X	±0.30
.XX	±0.20
.XXX	±0.10

 东莞市思量连接器有限公司  
DONGGUAN ADZL CONNECTORS CO.,LTD.

PART NO. 1018T-PVXX

TITLE 1.00mm Crimp Style Connectors

PROJECT	Ken	Wisely He	Allen	2023/10/17
APPROVAL				
CHECK				
DRAWN				
DATA				

UNIT	SCALE	NUMBER	REV
MM	1:1	8	

DATE	OLD REV	NEW REV	ECN	DESCRIPTION	CHECK	APPROVAL

RoHS

WWW.ADZLCONN.COM

TEL:0769-82285488

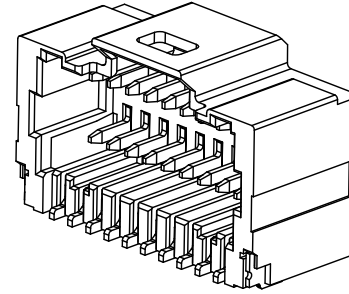

**Specifications :**

- Voltage rating: 50V AC / DC
- Current rating: 1.0A AC / DC
- Withstanding voltage: 250V AC/minute
- Temperature range: -25°C~+85°C
- Insulation resistance: ≥100MΩ
- Contact resistance: ≤20mΩ
- After environmental testing: ≤30mΩ

1018 W R S-2\*XX X-4T VXX XX

① ② ③ ④ ⑤ ⑥ ⑦ ⑧ ⑨

- ① Series No.
- ② Category: W-wafer
- ③ Welding Board Angle: R-Right Angle 90°
- ④ Welding Way: S-SMT
- ⑤ Row No.-Pin No.: 2\*XX-Double row
- ⑥ Plug the Pin & Special NO.
- ⑦ Material: 4T-PA4T 94V-0
- ⑧ Planting Category:  
Contact Area:V01:Gold flash V15:Gold 15u" Min.  
Solder Area: Gold flash.  
Underplated Nickel 50u"Min.
- ⑨ Color: Blank-Natural color  
BK-black

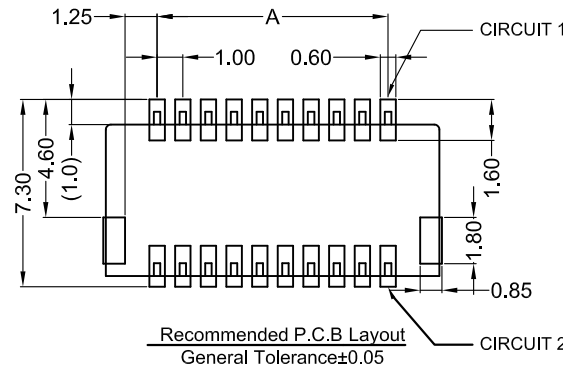
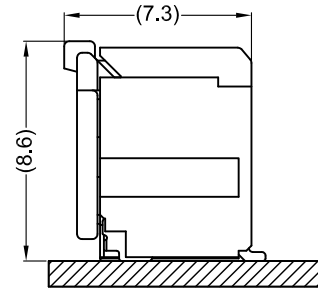
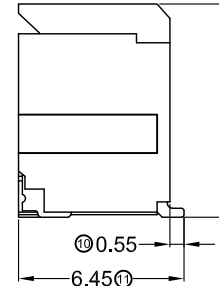
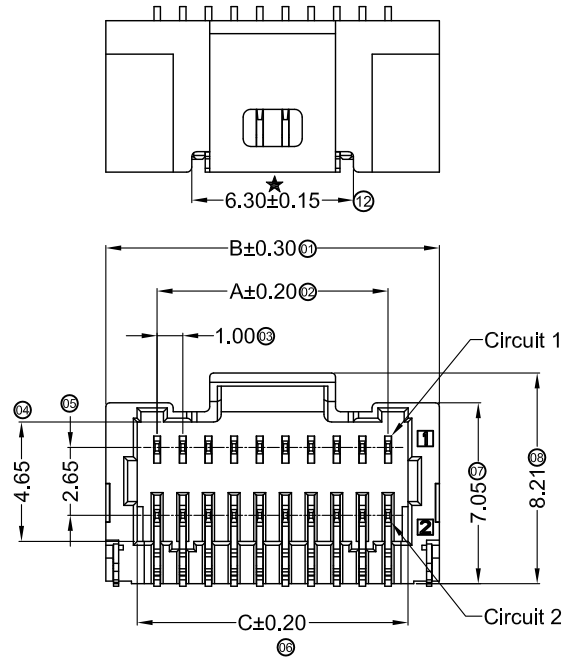

Poles	Dimensions (mm)		
	A	B	C
2*10	9.00	13.00	10.55
2*12	11.00	15.00	12.55
2*15	14.00	18.00	15.55
2*20	19.00	23.00	20.55
2*25	24.00	28.00	25.55

1018WRS-2*XX-4TV01	PA4T UL 94V-0 Natural	Phosphor Bronze	Gold-Flash	Brass	Matte Tin 100u" Min	1018H
PART NO	Material	Material(Pin)	Finish(Pin)	Material(Solder Tabs)	Finish(Solder Tabs)	Mates With ADZL Housing

				GENERAL TOLERANCE				东莞市思量连接器有限公司 DONGGUAN ADZL CONNECTORS CO.,LTD.				PART NO. 1018WRS-2*XX-4TVXXXX			
				.X ±0.30								TITLE 1.00mm Crimp Style Connectors			
				.XX ±0.20				APPROVAL Ken		CHECK Wisely He		DRAWN Allen		DATA 2023/05/16	
				.XXX ±0.10				PROJECT		UNIT MM		SCALE 1:1		NUMBER 8	
DATE	OLD REV	NEW REV	ECN	DESCRIPTION	CHECK	APPROVAL	PROJECT	Ken	Wisely He	Allen	2023/05/16	UNIT	SCALE	NUMBER	REV

1 2 3 4 5 6 7 8

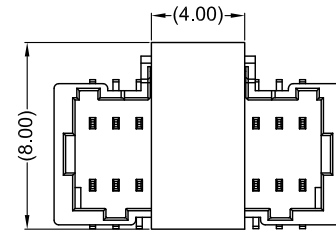
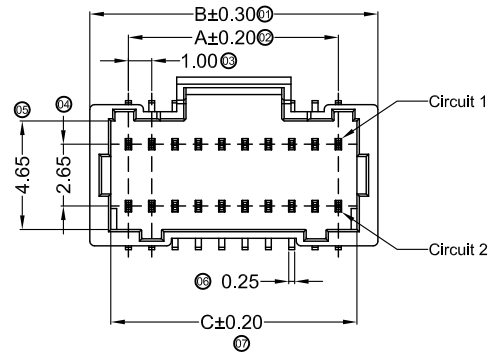

PICK AND PLACE AREA

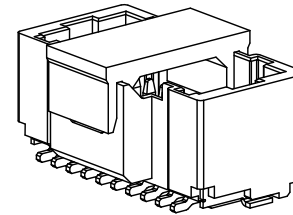

■ Specifications :

- Voltage rating: 50V AC / DC
- Current rating: 0.8A AC / DC
- Withstanding voltage: 250V AC/minute
- Temperature range: -25°C~+85°C
- Insulation resistance: ≥100MΩ
- Contact resistance: ≤20mΩ
- After environmental testing: ≤30mΩ

1018 W V S-2\*XX X-4T VXX XX

- ① Series No.
- ② Category: W-wafer
- ③ Welding Board Angle: V-180°
- ④ Welding Way: S-SMT
- ⑤ Row No.-Pin No.: 2\*XX-Double
- ⑥ Plug the Pin & Special NO.
- ⑦ Material: 4T-PA4T 94V-0
- ⑧ Planting Category:  
V01:Gold 1u" Min. V04:Gold 4u" Min.  
V15:Gold 15u" Min.
- ⑨ Color: Blank-Natural color  
BK-black

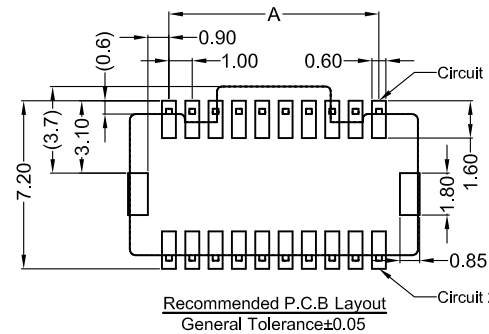
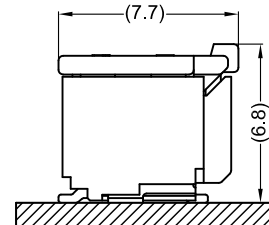
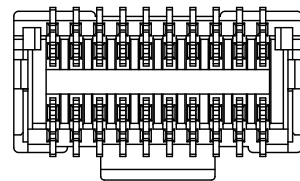
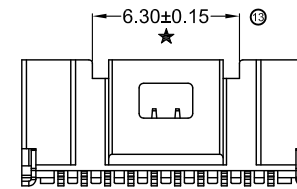
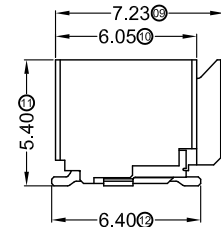
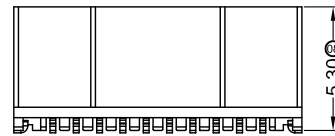

Poles	Dimensions (mm)		
	A	B	C
2*10	9.00	12.35	10.55
2*12	11.00	14.35	12.55
2*15	14.00	17.35	15.55
2*20	19.00	22.35	20.55
2*25	24.00	27.35	25.55

1018WVS-2*XX-4TV01	PA4T UL 94V-0 Natural	Phosphor Bronze	Gold Flash	Brass	Matte Tin Plating	1018H
PART NO	Material	Material(Pln)	Finish(Pln)	Material(Solder Tabs)	Finish(Solder Tabs)	Mates With ADZL Housing

GENERAL TOLERANCE

.X	±0.30
.XX	±0.20
.XXX	±0.10

ADZL 东莞市思量连接器有限公司  
DONGGUAN ADZL CONNECTORS CO.,LTD.

PART NO.  
1018WVS-2\*XX-4TVXXXX

APPROVAL CHECK DRAWN DATA

TITLE  
1.00mm Crimp Style Connectors

PROJECT  
Ken

Ken Wisely He Allen 2023/05/16

UNIT MM	SCALE 1:1	NUMBER	REV
------------	--------------	--------	-----

DATE	OLD REV	NEW REV	ECN	DESCRIPTION	CHECK	APPROVAL
1						