

Specifications :

- Voltage rating: 50V AC / DC
- Current rating: 1A AC / DC
- Withstanding voltage: 500V AC/minute
- Temperature range: -40°C~+105°C
- Insulation resistance: ≥100MΩ
- Contact resistance: ≤30mΩ
- After environmental testing: ≤50mΩ

1251 W R S-XX HF-LP XX XX-XX
 ① ② ③ ④ ⑤ ⑥ ⑦ ⑧ ⑨ ⑩

- ① Series No.
- ② Category: W-wafer
- ③ Welding Board Angle: R- Right Angle 90°
- ④ Welding Way: S-SMT
- ⑤ Row No.-Pin No.: XX-02P~15P
- ⑥ Plug the Pin & Special No.: HF-Halogen free
- ⑦ Material: LP-LCP 94V-0
- ⑧ Planting Category: SN-Bright Tin plating
SW-Matte Tin plating
- ⑨ Color: Blank-natural color
- ⑩ Mold No./Mark/Special No.

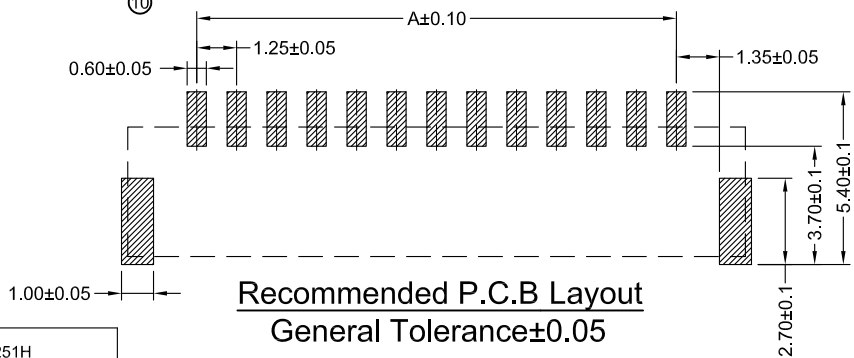
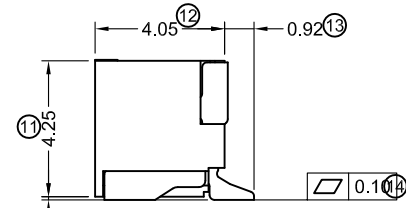
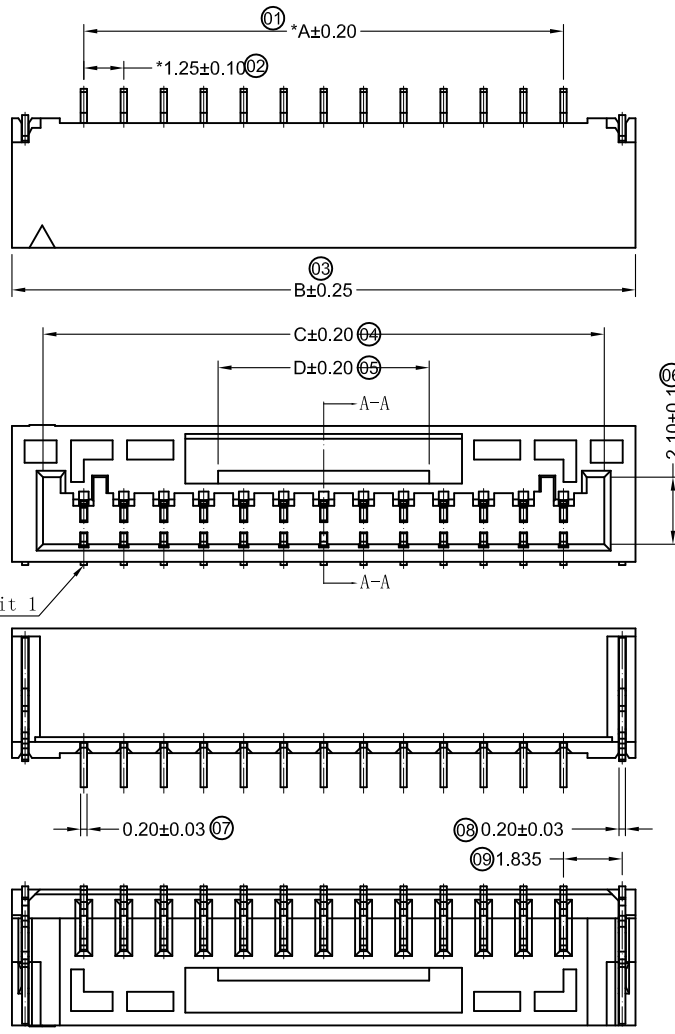

Ordering Information & Dimensions

Poles	Dimensions (mm)			
	A	B	C	D
02	1.25	5.75	3.80	0.80
03	2.50	7.00	5.05	1.60
04	3.75	8.25	6.30	2.50
05	5.00	9.50	7.55	2.50
06	6.25	10.75	8.80	4.50
07	7.50	12.00	10.05	4.50
08	8.75	13.25	11.30	4.50
09	10.00	14.50	12.55	4.50
10	11.25	15.75	13.80	6.10
12	13.75	18.25	16.30	6.10
13	15.00	19.50	17.55	6.10
14	16.25	20.75	18.80	6.10
15	17.50	22.00	20.05	6.10
16	18.75	23.25	21.30	6.10

1251WRS-XX-LPXX	LCP UL 94V-0 Halogen Free	Phorphos Bronze	Bright Tin plating/Matte Tin Plating	1251H
PART NO	Material	Material (Solder Tabs)	Finish (Solder Tabs)	Mates With ADZL Housing

GENERAL TOLERANCE				东莞市思量连接器有限公司 DONGGUAN ADZL CONNECTORS CO.,LTD.	PART NO. 1251WRS-XX-LPXX				
.X	±0.30	.XX	±0.20		TITLE 1.25mm Crimp Style Connectors				
.XXX	±0.10	APPROVAL	CHECK	DRAWN	DATE	UNIT	SCALE	NUMBER	REV
PROJECT	Ken	Zhao Hong	Allen	2022/1/21	MM	1:1		A	

DATE	OLD REV	NEW REV	ECN	DESCRIPTION	CHECK	APPROVAL
1						

RoHS  Lead-free

WWW.ADZLCONN.COM

TEL:0769-82285488

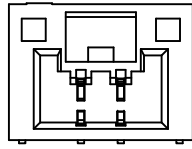

1*2P

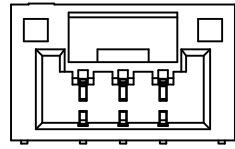

1*3P

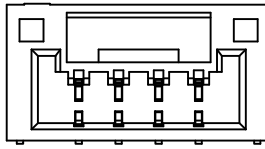

1*4P

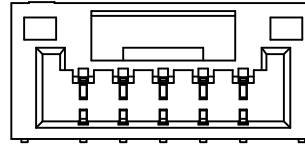

1*5P

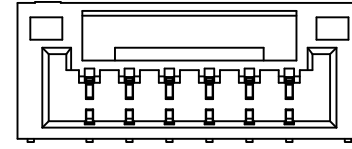

1*6P

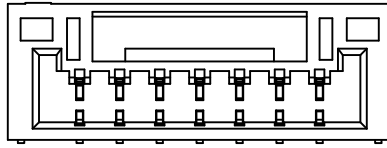

1*7P

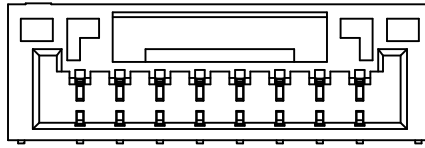

1*8P

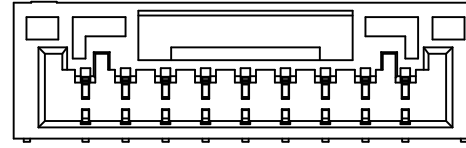

1*9P

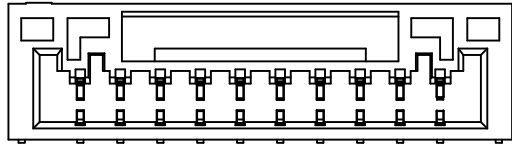

1*10P

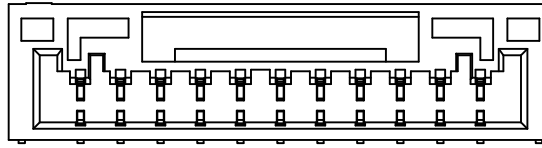

1*11P

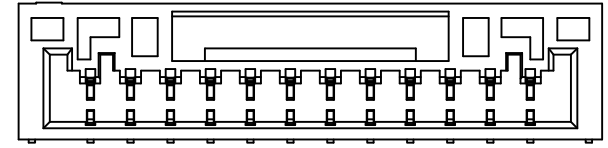

1*12P

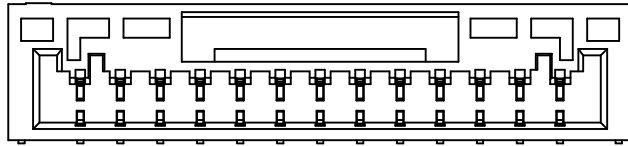

1*13P

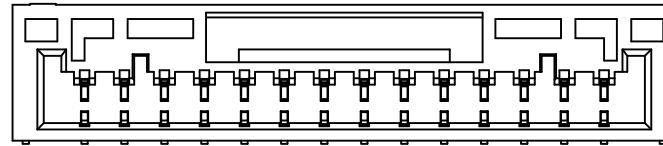

1*14P

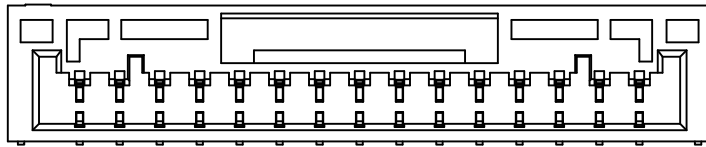

1*15P

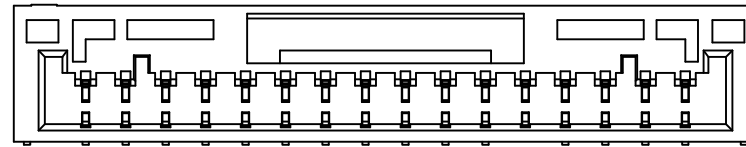

1*16P

DATE	OLD REV	NEW REV	ECN	DESCRIPTION	CHECK	APPROVAL
1						
2						
3						
4						

GENERAL TOLERANCE
 .X ±0.30
 .XX ±0.20
 .XXX ±0.10



 东莞市思量连接器有限公司
 DONGGUAN ADZL CONNECTORS CO.,LTD.

APPROVAL: Ken
 CHECK: Zhao Hong
 DRAWN: Allen
 DATE: 2022/1/21

PART NO. 1251WRS-XX-LPXX			
TITLE 1.25mm PIN位图			
UNIT MM	SCALE 1:1	NUMBER 8	REV A

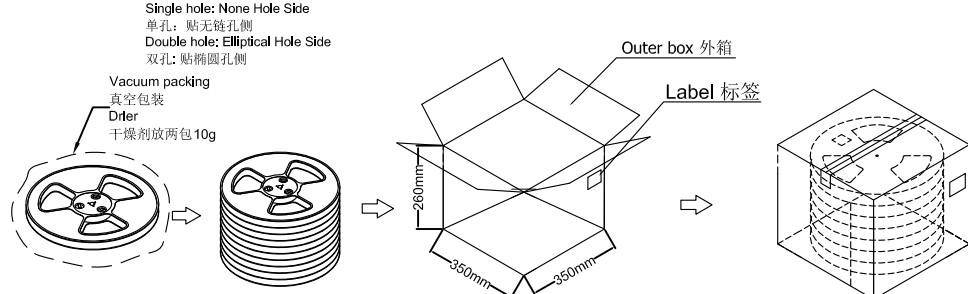
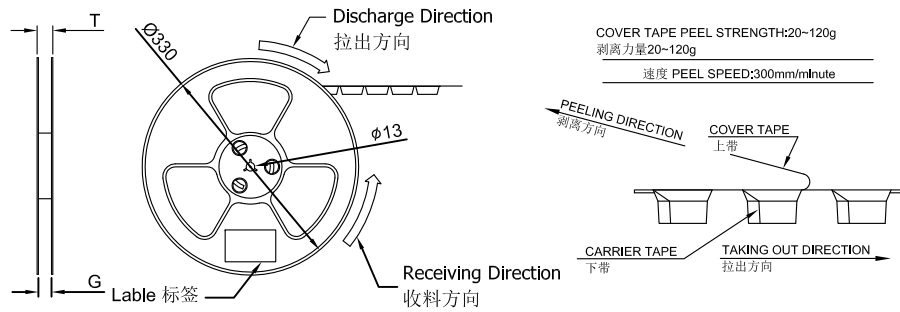
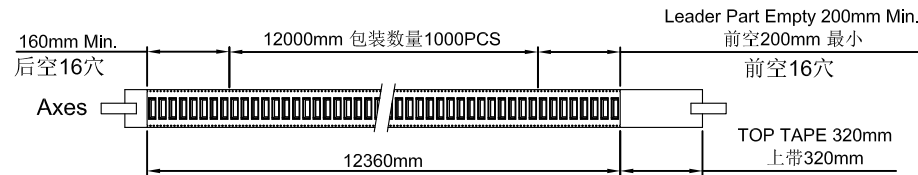

- Note:
- Carrier Camber Is Within 1mm In 100mm ; 带长100mm内容许弯曲度1mm
 - 10 Sprocket Hole Pitch Cumulative Tolerance±0.2MM ; 圆孔十个孔距离累计允许公差为±0.2mm
 - Material for PS ; 材质为PS材质; Color颜色: 透明色
 - bracer保护带: Color颜色:透明色;厚度0.40mm最小
 - Thinkness=0.40±0.05 ; 材料厚度为0.40±0.05mm
 - Cover Tape上带: 冷封
 - Carton material纸箱材质:K=K; Carton Thickness纸箱厚度: 6~7mm

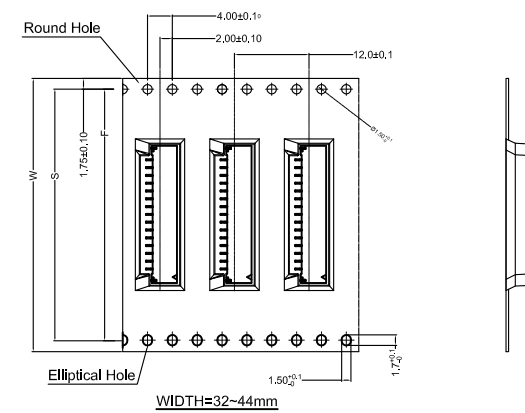
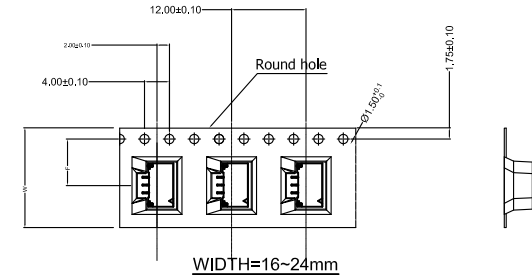

Carrier Tape No. 载带料号	W	S	F	T	G	REEL /PCS	CARTON /R
ZD1251WRS-02	16	/	7.50	20.50	16.50	1000	11R
ZD1251WRS-03							
ZD1251WRS-04							
ZD1251WRS-05	24	/	11.50	28.50	24.50	1000	8R
ZD1251WRS-06							
ZD1251WRS-07							
ZD1251WRS-08							
ZD1251WRS-09							
ZD1251WRS-10	32	28.40	14.20	36.50	32.50	1000	6R
ZD1251WRS-11							
ZD1251WRS-12							
ZD1251WRS-13	44	40.40	20.20	48.50	44.50	1000	5R
ZD1251WRS-14							
ZD1251WRS-15							

GENERAL TOLERANCE
.X ±0.30
.XX ±0.20
.XXX ±0.10

东莞市思量连接器有限公司
DONGGUAN ADZL CONNECTORS CO.,LTD.

PART NO. 1251WRS-XX-LPXX

TITLE 1.25mm 包装图

PROJECT

APPROVAL Ken CHECK Zhao Hong DRAWN Allen DATE 2022/1/21

UNIT MM SCALE 1:1 NUMBER REV A

DATE OLD REV NEW REV ECN DESCRIPTION CHECK APPROVAL

■ Specifications :

- Voltage rating: 50V AC / DC
- Current rating: 1A AC / DC
- Withstanding voltage: 500V AC/minute
- Temperature range: -40°C~+105°C
- Insulation resistance: ≥100MΩ
- Contact resistance: ≤30mΩ
- After environmental testing: ≤50mΩ

1251 W V S-XX XX-LP SN XX -XX
 ① ② ③ ④ ⑤ ⑥ ⑦ ⑧ ⑨ ⑩

- ① Series No.
- ② Category: W-wafer
- ③ Welding Board Angle: V- Stright 180°
- ④ Welding Way: S-SMT
- ⑤ Row No.-Pin No.: XX-02P~15P
- ⑥ Plug the Pin & Special No.: HF-Halogen free
- ⑦ Material: LP-LCP 94V-0
- ⑧ Planting Category:
SN-Bright tin plating ; SW-Matte Tin plating
- ⑨ Color: Blank-Natural color
- ⑩ Mold No./Mark/Special No.

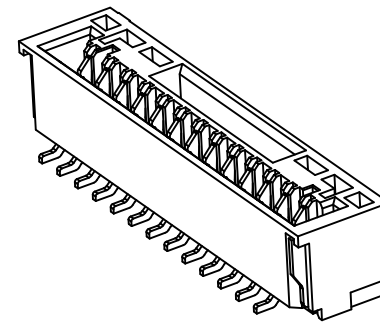
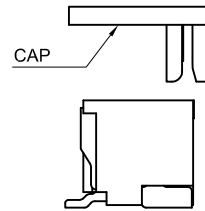
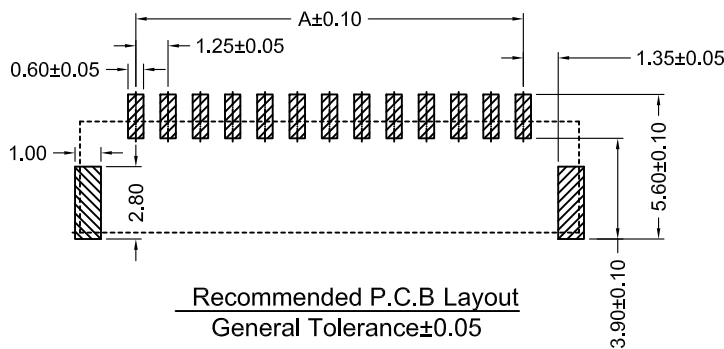
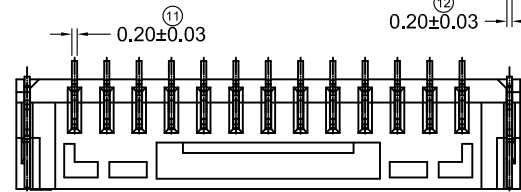
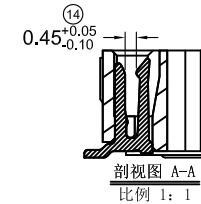
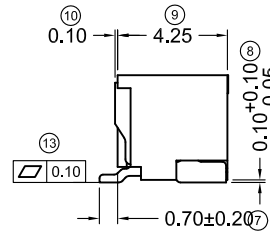
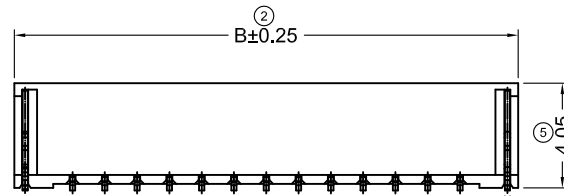
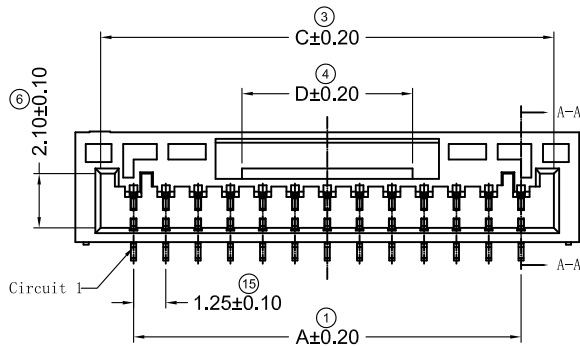

Ordering Information & Dimensions

Poles	Dimensions (mm)			
	A	B	C	D
02	1.25	5.75	3.80	0.80
03	2.50	7.00	5.05	1.60
04	3.75	8.25	6.30	2.50
05	5.00	9.50	7.55	2.50
06	6.25	10.75	8.80	4.50
07	7.50	12.00	10.05	4.50
08	8.75	13.25	11.30	4.50
09	10.00	14.50	12.55	4.50
10	11.25	15.75	13.80	6.10
11	12.50	17.00	15.05	6.10
12	13.75	18.25	16.30	6.10
13	15.00	19.50	17.55	6.10
14	16.25	20.75	18.80	6.10
15	17.50	22.00	20.05	6.10

1251WVS-XX-LPSW	LCP UL 94V-0 Halogen Free	Phorphos Bronze	Tin Plating Matte Tin 70u" Min. Over Ni 30u"	1251H
PART NO	Material	Material(Pin)	Finish(Pin)	Mates With ADZL Housing

GENERAL TOLERANCE
.X ±0.30
.XX ±0.20
.XXX ±0.10

东莞市思量连接器有限公司
DONGGUAN ADZL CONNECTORS CO.,LTD.

PART NO. 1251WVS-XX-LPXX

TITLE 1.25mm Crimp Style Connectors

PROJECT

APPROVAL	CHECK	DRAWN	DATA
Ken	Zhao Hong	Allen	2022/5/28

UNIT	SCALE	NUMBER	REV
MM	1:1	8	C

DATE	OLD REV	NEW REV	ECN	DESCRIPTION	CHECK	APPROVAL
1			2			

RoHS  Lead-free

WWW.ADZLCONN.COM

TEL:0769-82285488

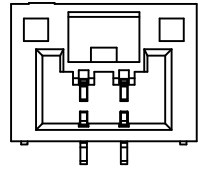

1*2P

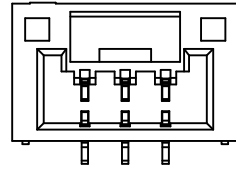

1*3P

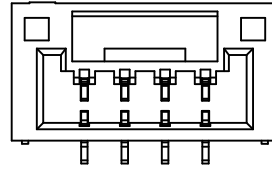

1*4P

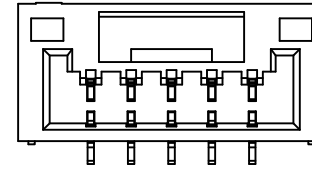

1*5P

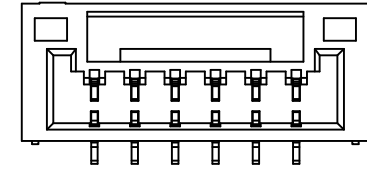

1*6P

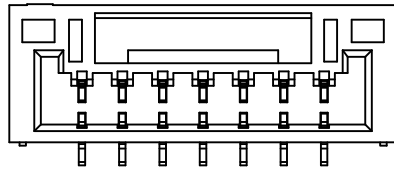

1*7P

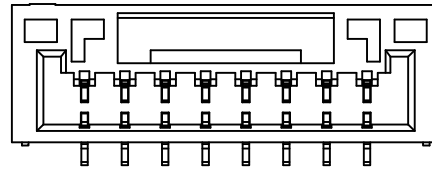

1*8P

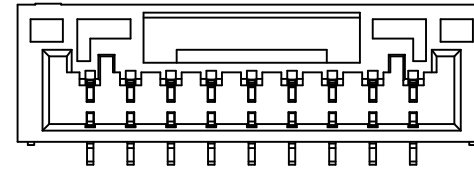

1*9P

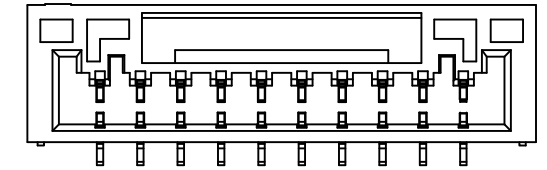

1*10P

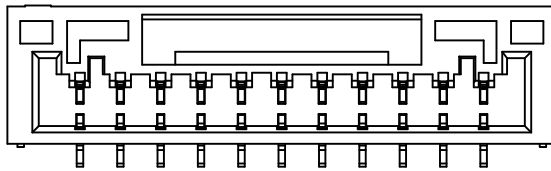

1*11P

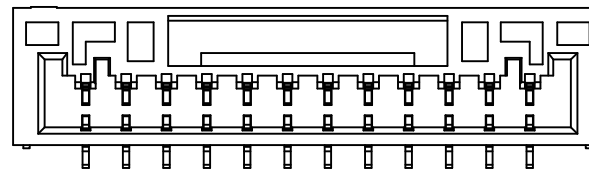

1*12P

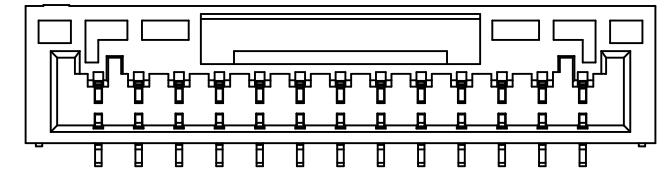

1*13P

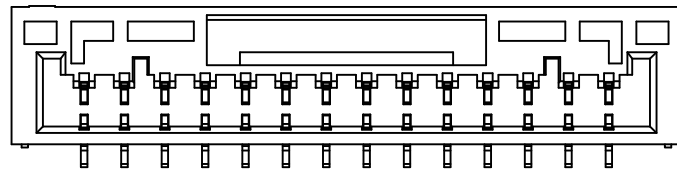

1*14P

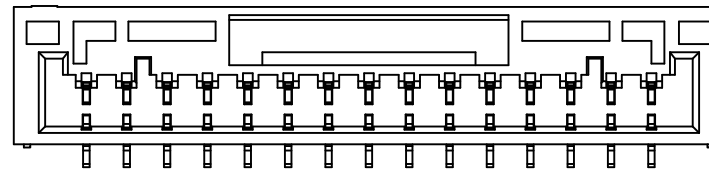

1*15P

DATE	OLD REV	NEW REV	ECN	DESCRIPTION	CHECK	APPROVAL
1						
2						
3						
4						

GENERAL TOLERANCE
 .X ±0.30
 .XX ±0.20
 .XXX ±0.10



 东莞市思量连接器有限公司
 DONGGUAN ADZL CONNECTORS CO.,LTD.

APPROVAL	CHECK	DRAWN	DATA
Ken	Zhao Hong	Allen	2022/5/28

PART NO. 1251WVS-XX-LPXX

TITLE 1.25mm PIN位图

UNIT	SCALE	NUMBER	REV
MM	1:1	8	C

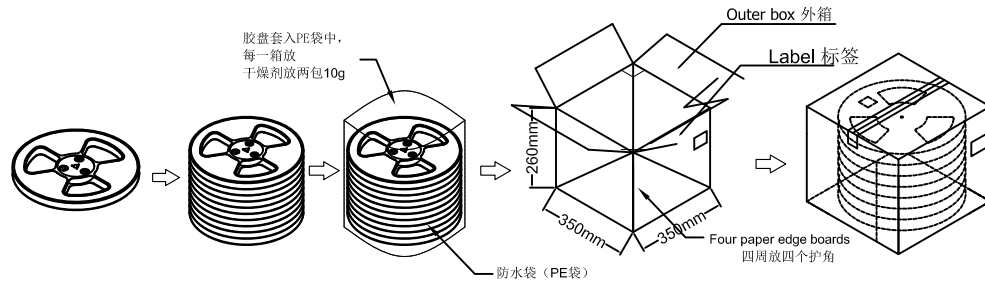
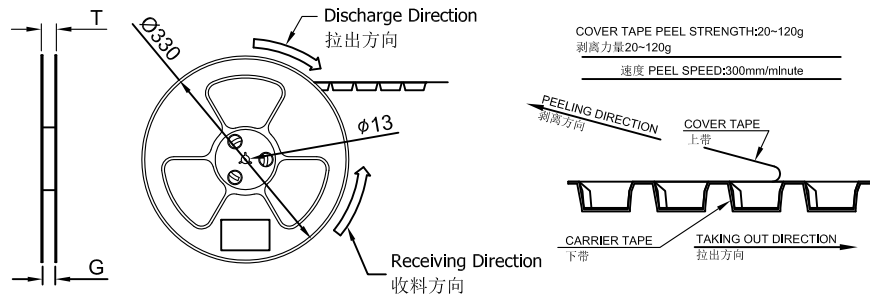
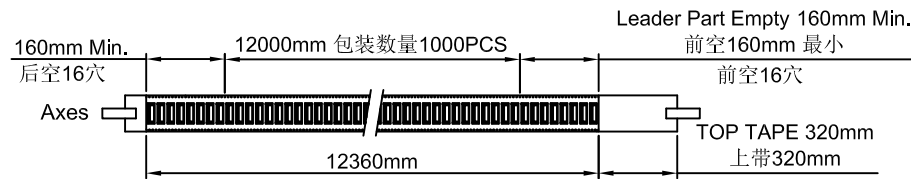

Note:

- Carrier Camber Is Within 1mm In 100mm ; 带长100mm 内容许弯曲度1mm
- 10 Sprocket Hole Pitch Cumulative Tolerance±0.2MM ; 圆孔十个孔距离累计允许公差为±0.2mm
- Material for PS ; 材质为PS材质; Color颜色: Black黑色
- bracer保护带: Color颜色:Black黑色;厚度0.40mm最小
- Thickness=0.40±0.05 ; 材料厚度为0.40±0.05mm
- Cover Tape上带: 冷封
- Carton material纸箱材质:K=K; Carton Thickness纸箱厚度: 6~7mm

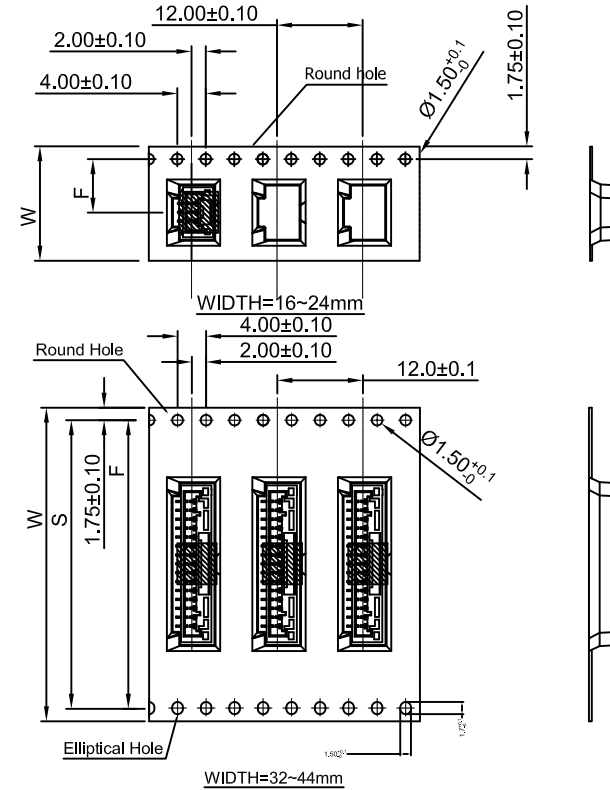

Carrier Tape No. 载带料号	W	S	F	T	G	REEL /PCS	CARTON /R	CARTON /PCS
ZD1251WVS-02	16	/	7.50	20.50	16.50	1000	11R	11000
ZD1251WVS-03								
ZD1251WVS-04								
ZD1251WVS-05								
ZD1251WVS-06								
ZD1251WVS-07	24	/	11.50	28.50	24.50	1000	8R	8000
ZD1251WVS-08								
ZD1251WVS-09								
ZD1251WVS-10	32	28.40	14.20	36.50	32.50	1000	6R	6000
ZD1251WVS-11								
ZD1251WVS-12								
ZD1251WVS-13								
ZD1251WVS-14								
ZD1251WVS-15	44	40.40	20.20	48.50	44.50	1000	5R	5000

DATE	OLD REV	NEW REV	ECN	DESCRIPTION	CHECK	APPROVAL	PROJECT

GENERAL TOLERANCE	
.X	±0.30
.XX	±0.20
.XXX	±0.10

ADZL 东莞市思量连接器有限公司
DONGGUAN ADZL CONNECTORS CO.,LTD.

APPROVAL	CHECK	DRAWN	DATA
Ken	Zhao Hong	Allen	2022/5/28

PART NO.		1251WVS-XX-LPXX	
TITLE			
1.25mm 包装图			
UNIT	SCALE	NUMBER	REV
MM	1:1		C

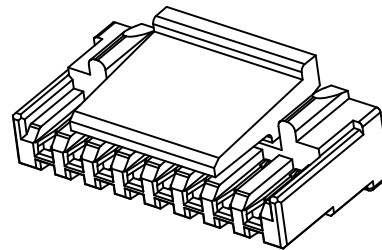
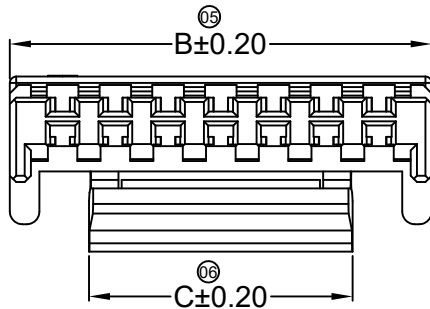
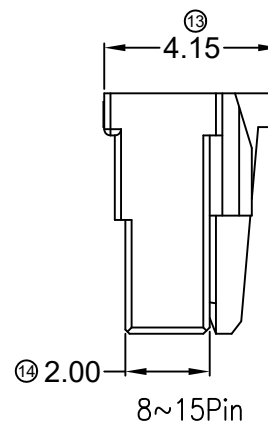
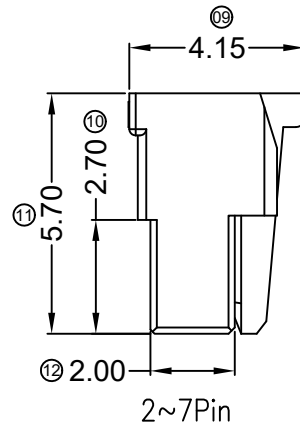
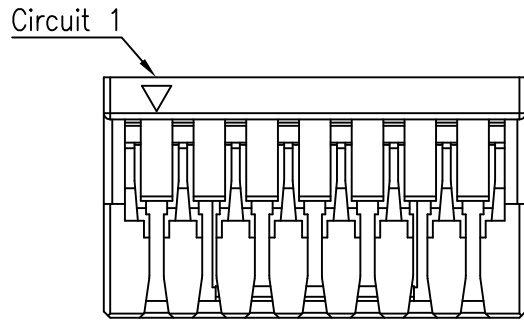
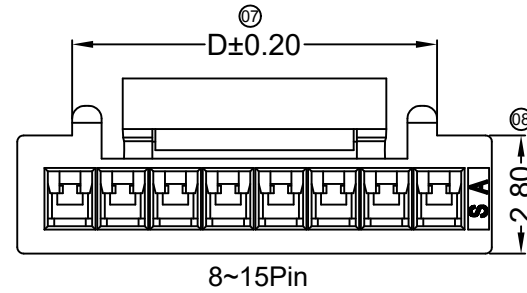
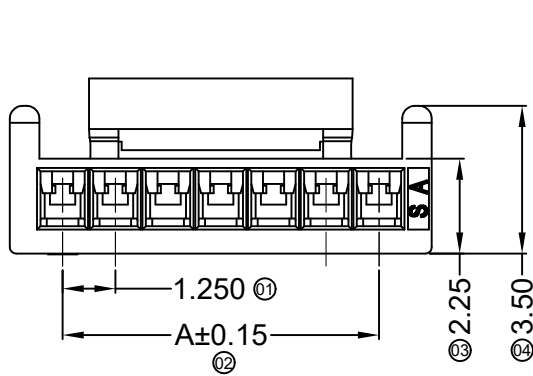

■ Specifications :

- Voltage rating: 50V AC / DC
- Current rating: 1A AC / DC
- Withstanding voltage: 500V AC/minute
- Temperature range: -40°C~+105°C
- Insulation resistance: ≥100MΩ
- Contact resistance: ≤30mΩ
- After environmental testing: ≤50mΩ
- Suitable ADZL Terminal: 1251T-A
- Suitable ADZL Wafer: 1251W

1251 H X - XX X - N0 HF XX
 (1) (2)(3) (4) (5) (6) (7) (8)

- ① Series No.
- ② Category: H-HSG
- ③ Connector type: Blank-ordinary
- ④ Row No.-Pin No per row: XX-02P~15P
- ⑤ Special No.:Blank-ordinary
A-New design
- ⑥ Material: N0-PA66 94V-0
- ⑦ HF-Halogen free
- ⑧ Color: N-Natural; B-Black; R-Red; L-Blue

Poles	Dimensions (mm)				Poles	Dimensions (mm)			
	A	B	C	D		A	B	C	D
02	1.25	3.75	2.10	/	09	10.00	12.50	6.25	8.65
03	2.50	5.00	3.00	/	10	11.25	13.75	8.20	10.70
04	3.75	6.25	4.05	/	11	12.50	15.00	8.20	10.70
05	5.00	7.50	4.25	/	12	13.75	16.25	8.20	10.70
06	6.25	8.75	6.25	/	13	15.00	17.50	8.20	10.70
07	7.50	10.00	6.25	/	14	16.25	18.75	8.20	10.70
08	8.75	11.25	6.25	8.65	15	17.50	20.00	8.20	10.70

DATE	REV	ECN NO.	DESCRIPTION	MODIFY	APPROVAL

GENERAL TOLERANCE
.X ±0.30
.XX ±0.20
.XXX ±0.10
X.° ±2°
PROJECT

ADZL 东莞市思量连接器有限公司
 DONGGUAN ADZL CONNECTORS CO.,LTD.

APPROVAL	CHECK	DRAWN	DATE
Ken	Zhao Hong	Allen	2018/08/25

PART NO. 1251H-XX-N0HF				
TITLE 1.25mm Crimp Style Connectors				
UNIT	SCALE	SHEET	REV	NUMBER
mm	1:1	1/1		

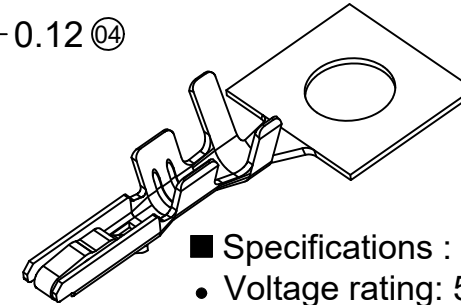
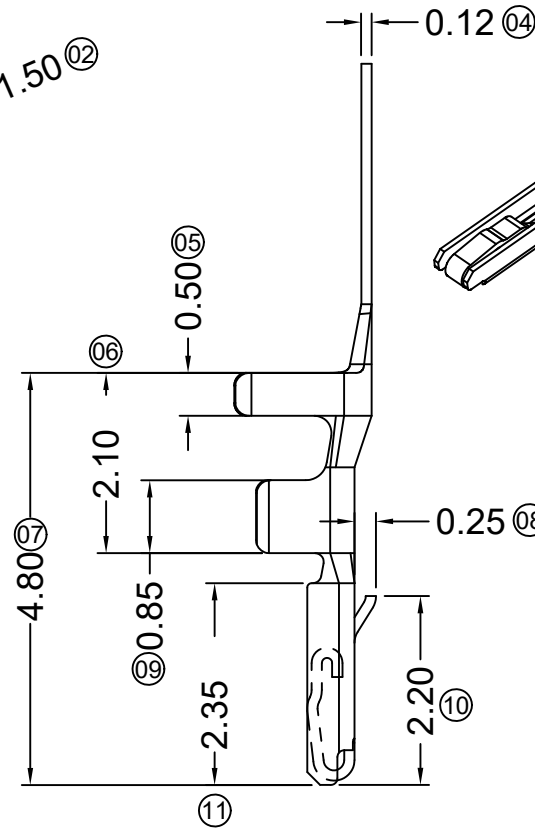
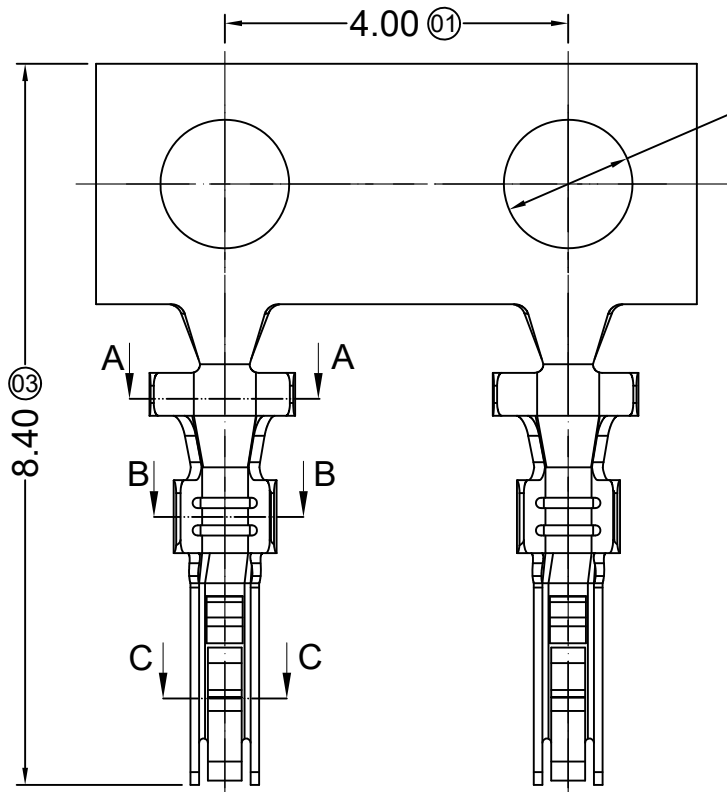

■ Specifications :

- Voltage rating: 50V AC / DC
- Current rating: 1A AC / DC
- Withstanding voltage: 500V AC/minute
- Temperature range: -40°C~+105°C
- Insulation resistance: ≥100MΩ
- Contact resistance: ≤30mΩ
- After environmental testing: ≤50mΩ
- Wire Size: AWG # 26~30 (0.13~0.05mm²)
- Insulation Ø O.D.: 1.00mm (Max)
- Mates With ADZL Housing: 1251H

1251 T - P XXX - X
 (1) (2) (3) (4) (5)

- ① Series Number
- ② Category: T-terminal
- ③ Material: P-Phosphor bronze
- ④ Plating style:
 V01-Gold Flash ;
 SN-Bright tin plating;
 V30-Contact Area Gold 30u"Min.;
 Other Area G/F Ni 30u" Min.
- ⑤ Special No.:A-New design

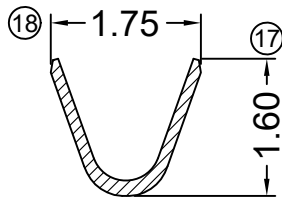

SECTION: A-A
SCALE: 1:1

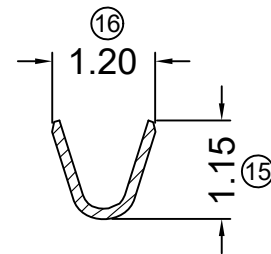

SECTION: B-B
SCALE: 1:1

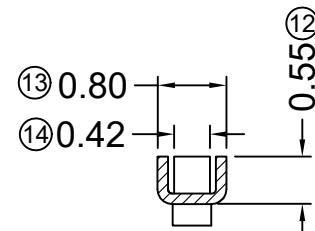

SECTION: C-C
SCALE: 1:1

DATE	REV	ECN NO.	DESCRIPTION	MODIFY	APPROVAL
1		2	3	4	5

GENERAL TOLERANCE
.X ±0.30
.XX ±0.20
.XXX ±0.10
X.° ±2°
PROJECT

东莞市思量连接器有限公司 DONGGUAN ADZL CONNECTORS CO.,LTD.			
APPROVAL	CHECK	DRAWN	DATE
Ken	Zhao Hong	Allen	2018/08/25

PART NO. 1251T-PXX				
TITLE 1.25mm Crimp Style Connectors				
UNIT	SCALE	SHEET	REV	NUMBER
mm	1:1	1/1		