

Specifications :

- Voltage rating: 250V AC / DC
- Current rating: 1A AC / DC
- Withstanding voltage: 500V AC/minute
- Temperature range: -25°C~+85°C
- Insulation resistance: ≥100MΩ
- Contact resistance: ≤30mΩ
- After environmental testing: ≤40mΩ
- Mates With ADZL Housing :1276HI

1276 K V S- 2*XX C-XX XXX XX
 ① ② ③ ④ ⑤ ⑥ ⑦ ⑧ ⑨

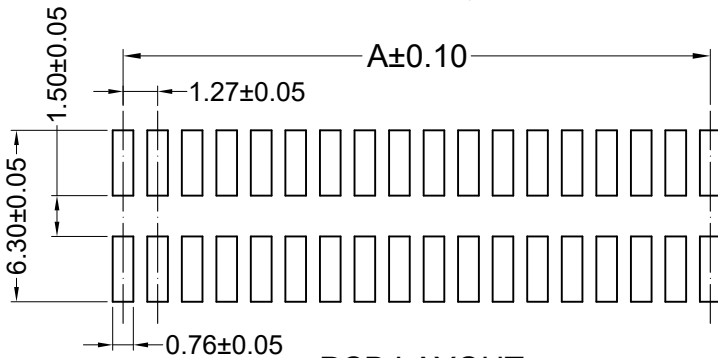
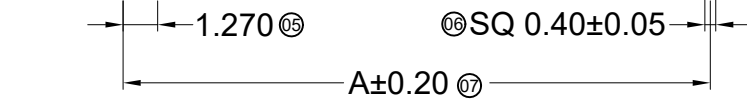
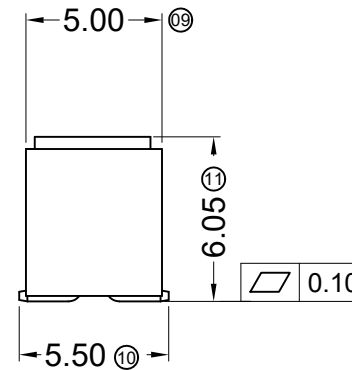
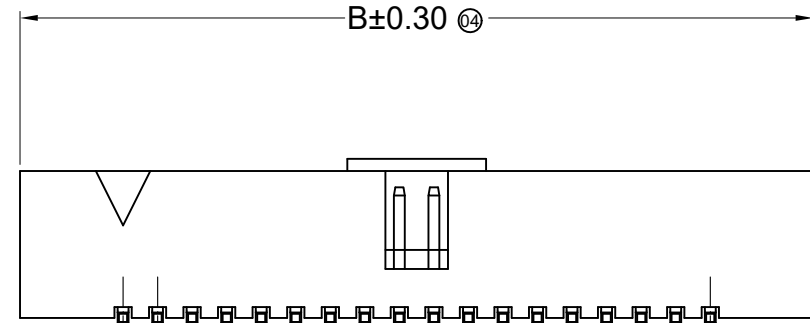
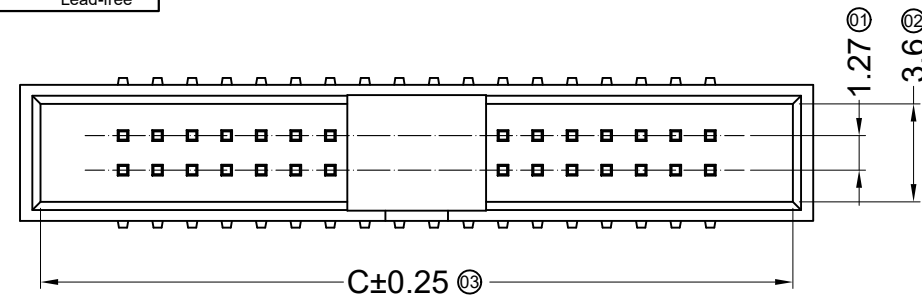

- ① Series No.
- ② Category: K-Cowfish Longhorn Connector
- ③ Welding Board Angle: V-180° ; R-90°
- ④ Welding Way: Blank-DIP ; S-SMT
- ⑤ Row No.-Pin No.: XX-Single Row ; 2*XX-Double Row
- ⑥ Plug the Pin & Special No. : C-With Cap
- ⑦ Material: 6T -PA6T 94V-0 ; 9T -PA9T 94V-0 ; 1T -PA10T 94V-0 ; 46 -PA46T 94V-0 ; LP-LCP 94V-0
- ⑧ Planting Category: V01-All Gold Flash ; SN-Bright tin plating ;
- ⑨ Color: Blank-natural color

Poles	Dimensions (mm)			Poles	Dimensions (mm)		
	A	B	C		A	B	C
2*02	1.27	8.84	7.34	2*14	16.51	24.08	22.55
2*03	2.54	10.11	8.61	2*15	17.78	25.35	23.82
2*04	3.81	11.38	9.88	2*16	19.05	26.62	25.09
2*05	5.08	12.65	11.15	2*17	20.32	27.89	26.36
2*06	6.35	13.92	12.42	2*18	21.59	29.16	27.63
2*07	7.62	15.19	13.69	2*19	22.86	30.43	28.90
2*08	8.89	16.46	14.96	2*20	24.13	31.70	30.17
2*09	10.16	17.73	16.20	2*21	25.40	32.97	31.44
2*10	11.43	19.00	17.47	2*25	30.48	38.05	36.52
2*11	12.70	20.27	18.74	2*30	36.83	44.40	42.87
2*12	13.97	21.54	20.01	2*32	39.37	46.94	45.41
2*13	15.24	22.81	21.28	2*34	41.91	49.48	47.95



PCB LAYOUT

DATE	OLD REV	NEW REV	ECN	DESCRIPTION	CHECK	APPROVAL

GENERAL TOLERANCE	
.X	±0.30
.XX	±0.20
.XXX	±0.10
PROJECT	
	

ADZL 东莞市思量连接器有限公司
 DONGGUAN ADZL CONNECTORS CO.,LTD.

APPROVAL	CHECK	DRAWN	DATA
Ken	Zhao Hong	Allen	2018/08/01

PART NO.			
1276KVS-2*XXC-XXXXX			
TITLE			
1.27 mm Box Header Connector			
UNIT	SCALE	NUMBER	REV
MM	1 : 1		

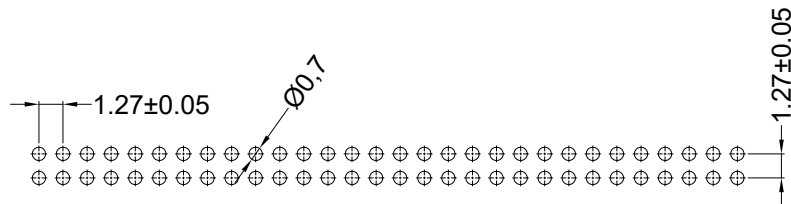
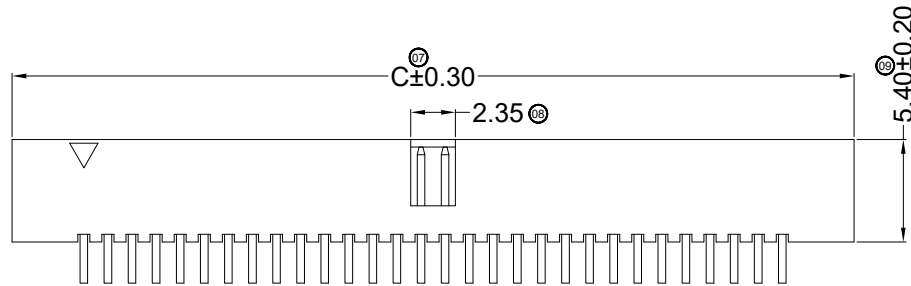
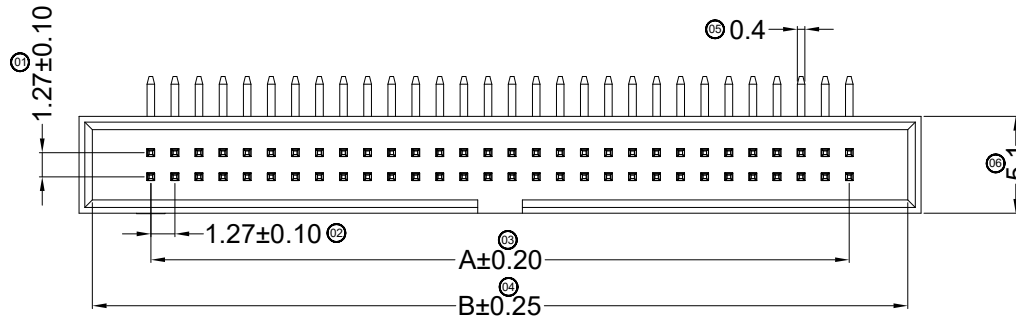

Recommended PCB Layout

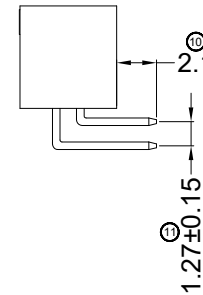

Specifications :

- Voltage rating: 250V AC / DC
- Current rating: 0.5A AC / DC
- Withstanding voltage: 500V AC/minute
- Temperature range: -25°C~+85°C
- Insulation resistance: ≥100MΩ
- Contact resistance: ≤30mΩ
- After environmental testing: ≤40mΩ
- Mates With ADZL Housing :1276HI



1276 K R X- 2*XX X-6T V01 XX

① ② ③ ④ ⑤ ⑥ ⑦ ⑧ ⑨

- ① Series No.
- ② Category: K-Cowfish Longhorn Connector
- ③ Welding Board Angle: V-180° ; R-90°
- ④ Welding Way: Blank-DIP ; S-SMT
- ⑤ Row No.-Pin No.: XX-Single Row ; 2*XX-Double Row
- ⑥ Plug the Pin & Special No. :
- ⑦ Material: 6T -PA6T 94V-0 ; 9T -PA9T 94V-0 ; 1T -PA10T 94V-0 46 -PA46T 94V-0
- ⑧ Plating Category: 01-Gold Flash 02-2u" 03-3u" SN-Bright Tin Plating (70-120u")
- ⑨ Color : Blank-Natural Color

Poles	Dimensions (mm)			Poles	Dimensions (mm)		
	A	B	C		A	B	C
2*02	1.27	7.43	8.84	2*11	12.70	18.87	20.27
2*03	2.54	8.70	10.11	2*12	13.97	20.14	21.54
2*04	3.81	9.98	11.38	2*13	15.24	21.41	22.81
2*05	5.08	11.25	12.65	2*15	17.78	23.95	25.35
2*06	6.35	12.52	13.92	2*17	20.32	26.49	27.89
2*07	7.62	13.79	15.19	2*20	24.13	30.30	31.70
2*08	8.89	15.06	16.46	2*25	30.48	36.65	38.05
2*09	10.16	16.33	17.73	2*30	36.83	43.00	44.40
2*10	11.43	17.60	19.00				

DATE	OLD REV	NEW REV	ECN	DESCRIPTION	CHECK	APPROVAL

GENERAL TOLERANCE	
.X	±0.30
.XX	±0.20
.XXX	±0.10
PROJECT	
	

ADZL 东莞市思量连接器有限公司
DONGGUAN ADZL CONNECTORS CO.,LTD.

APPROVAL	CHECK	DRAWN	DATA
Ken	Zhao Hong	Allen	2018/08/01

PART NO. 1276KR-2*XX-XTV01			
TITLE 1.27 mm Crimp Style Connector			
UNIT MM	SCALE 1 : 1	NUMBER	REV

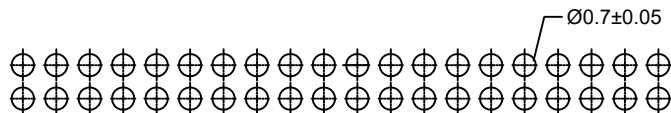
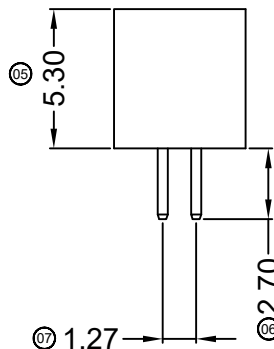
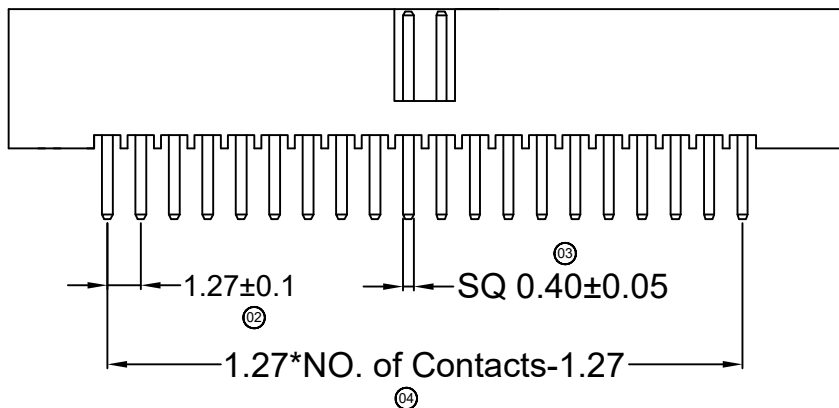
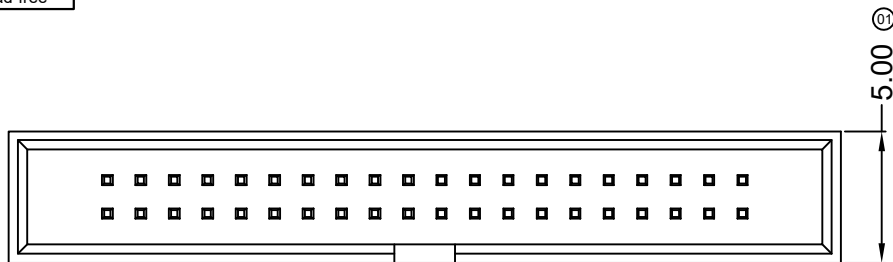

P.C.B Layout

■ Specifications :

- Voltage rating: 250V AC / DC
- Current rating: 0.5A AC / DC
- Withstanding voltage: 500V AC/minute
- Temperature range: -25°C~+85°C
- Insulation resistance: ≥100MΩ
- Contact resistance: ≤30mΩ
- After environmental testing: ≤40mΩ
- Mates With ADZL Housing :1276HI

1276 K V X- 2*XX X-LP V01 XX
 ① ② ③ ④ ⑤ ⑥ ⑦ ⑧ ⑨

- ① Series No.
- ② Category: K-Cowfish Longhorn Connector
- ③ Welding Board Angle: V-180° ; R-90°
- ④ Welding Way: Blank-DIP ; S-SMT
- ⑤ Row No.-Pin No.: XX-Single Row ; 2*XX-Double Row
- ⑥ Plug the Pin & Special No. :
- ⑦ Material: 6T -PA6T 94V-0 ; 9T -PA9T 94V-0 ; 1T -PA10T 94V-0
46 -PA46T 94V-0 ; LP -LCP 94V-0
- ⑧ Plating Category:
01-Gold Flash 02-2u" 03-3u"
SN-Bright Tin Plating (70-120u")
- ⑨ Color : Blank-Natural Color

							 东莞市思量连接器有限公司 DONGGUAN ADZL CONNECTORS CO.,LTD.				PART NO. 1276KV-2*XX-XXV01			
							APPROVAL				TITLE 1.27 mm Crimp Style Connector			
							Ken				Zhao Hong			
							Allen				2017/08/01			
DATE	OLD REV	NEW REV	ECN	DESCRIPTION	CHECK	APPROVAL	PROJECT	UNIT MM	SCALE 1:1	NUMBER	REV			

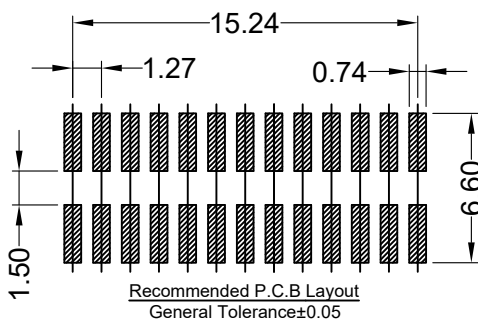
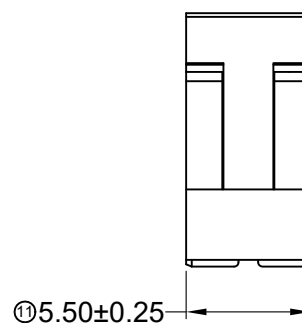
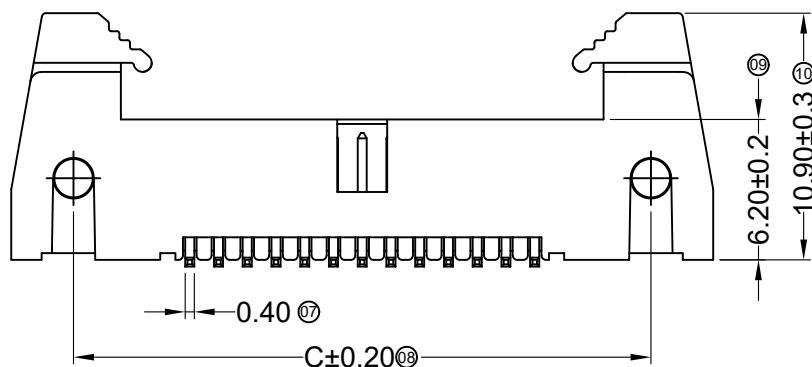
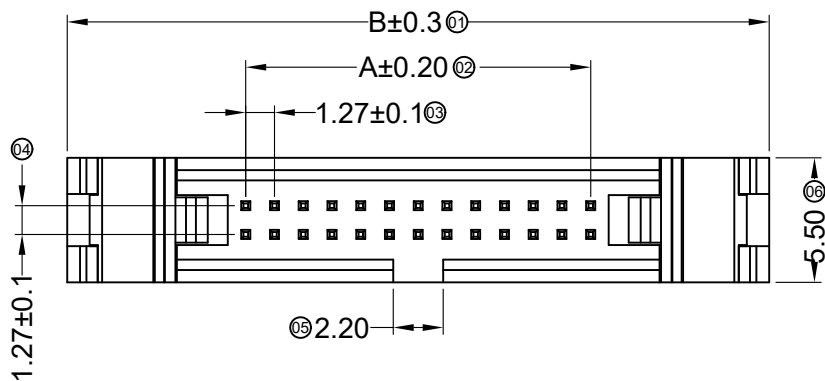

Specifications :

- Voltage rating: 250V AC / DC
- Current rating: 1A AC / DC
- Withstanding voltage: 500V AC/minute
- Temperature range: -25°C~+85°C
- Insulation resistance: ≥100MΩ
- Contact resistance: ≤30mΩ
- After environmental testing: ≤40mΩ
- Mates With ADZL Housing :1276HI

1276 K V S-2*XX A- XX V01 XX

① ②③④ ⑤ ⑥ ⑦ ⑧ ⑨

- ① Series No.
- ② Category: K-Cowfish Longhorn Connector
- ③ Welding Board Angle: V- Straight 180°
- ④ Welding Way: S-SMT
- ⑤ Row No.-Pin No.: 2*XX-Double Row
- ⑥ Plug the Pin & Special No.:
A-Cowfish Longhorn with Lock
- ⑦ Material: 6T -PA6T 94V-0 ; 9T -PA9T 94V-0 ;
1T -PA10T 94V-0 ; 46 -PA46T 94V-0 ;
LP -LCP 94V-0
- ⑧ Planting Category: V01-All Gold Flash;
SN-Bright tin plating ;
- ⑨ Color: Blank-natural color

Poles	Dimensions (mm)			Poles	Dimensions (mm)		
	A	B	C		A	B	C
2*03	2.54	18.31	12.81	2*15	17.78	33.55	28.05
2*04	3.81	19.58	14.08	2*17	20.32	36.09	30.59
2*05	5.08	20.85	15.35	2*20	24.13	39.90	34.40
2*07	7.62	23.39	17.89	2*25	30.48	46.25	40.75
2*08	8.89	24.66	19.16	2*30	36.83	52.60	47.10
2*09	10.16	25.93	20.43	2*32	39.37	55.14	49.64
2*10	11.43	27.20	21.70	2*34	41.91	57.68	52.18
2*13	15.24	31.01	25.51				

DATE	OLD REV	NEW REV	ECN	DESCRIPTION	CHECK	APPROVAL

GENERAL TOLERANCE

.X	±0.30
.XX	±0.20
.XXX	±0.10



 东莞市思量连接器有限公司
DONGGUAN ADZL CONNECTORS CO.,LTD.

APPROVAL	CHECK	DRAWN	DATA
Ken	Zhao Hong	Allen	2017/08/01

PART NO. 1276KVS-2*XXA-XXXXX			
TITLE 1.27 mm Crimp Style Connectors			
UNIT MM	SCALE 1:1	NUMBER	REV

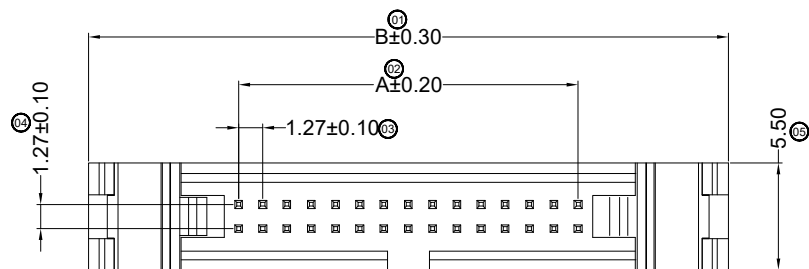

■ Specifications :

- Voltage rating: 250V AC / DC
- Current rating: 0.5A AC / DC
- Withstanding voltage: 500V AC/minute
- Temperature range: -25°C~+85°C
- Insulation resistance: ≥100MΩ
- Contact resistance: ≤30mΩ
- After environmental testing: ≤40mΩ
- Mates With ADZL Housing :1276HI

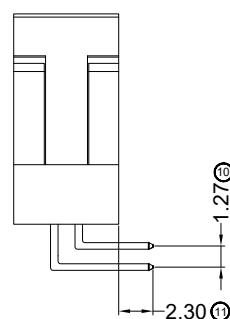
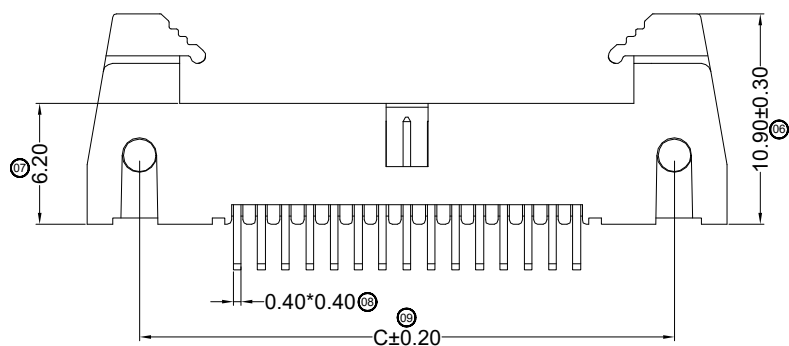

1276 K R X- 2*XX A-PT XXX XX

① ② ③ ④ ⑤ ⑥ ⑦ ⑧ ⑨

- ① Series No.
- ② Category: K-Cowfish Longhorn Connector
- ③ Welding Board Angle: V-180° ; R-90°
- ④ Welding Way: Blank-DIP ; S-SMT
- ⑤ Row No.-Pin No.: XX-Single Row ; 2*XX-Double Row
- ⑥ Plug the Pin & Special No.: A-Cowfish Longhorn with Lock
- ⑦ Material: PT -PBT 94V-0
- ⑧ Plating Category: Planting Category: V01-All Gold Flash; SN-Bright tin plating ;
- ⑨ Color: Blank-natural color

Poles	Dimensions (mm)		
	A	B	C
06	2.54	18.31	12.81
08	3.81	19.58	14.08
10	5.08	20.85	15.35
14	7.62	23.39	17.89
16	8.89	24.66	19.16
18	10.16	25.93	20.43
20	11.43	27.20	21.70
26	15.24	31.01	25.51
30	17.78	33.55	28.05
34	20.32	36.09	30.59
40	24.13	39.90	34.40
50	30.48	46.25	40.75
60	36.83	52.60	47.10
64	39.37	55.14	49.64
68	41.91	57.68	52.18

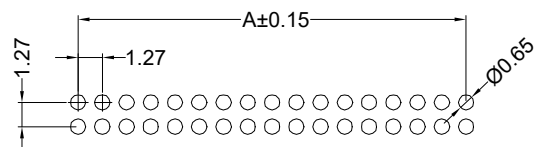

P.C.B Board Layout

DATE	OLD REV	NEW REV	ECN	DESCRIPTION	CHECK	APPROVAL

GENERAL TOLERANCE	
.X	±0.30
.XX	±0.20
.XXX	±0.10

 东莞市思量连接器有限公司
DONGGUAN ADZL CONNECTORS CO.,LTD.

APPROVAL	CHECK	DRAWN	DATA
Ken	Zhao Hong	Allen	2017/08/01

PART NO. 1276KR-2*XXA-PTXXX			
TITLE 1.27 mm Crimp Style Connector			
UNIT MM	SCALE 1 : 1	NUMBER	REV

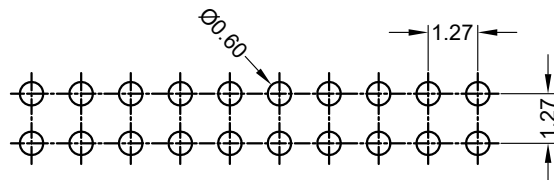
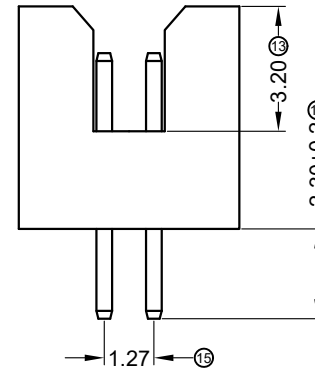
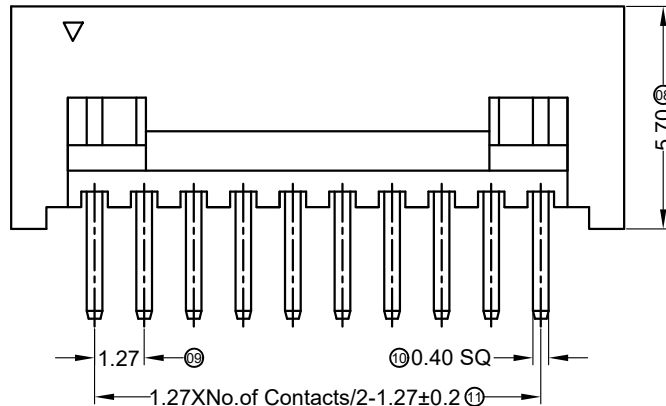
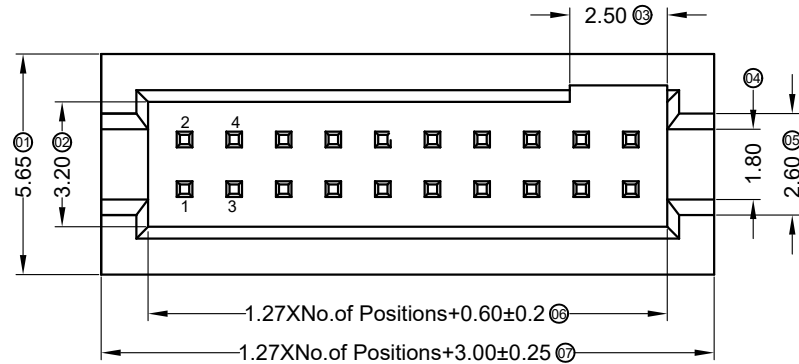

Recommended P.C.B Layout
General Tolerance±0.05

■ Specifications :

- Voltage rating: 250V AC / DC
- Current rating: 1A AC / DC
- Withstanding voltage: 500V AC/minute
- Temperature range: -25°C~+85°C
- Insulation resistance: ≥100MΩ
- Contact resistance: ≤30mΩ
- After environmental testing: ≤40mΩ
- Mates With ADZL Housing :1276HI

1276 K V X-2*XX B-XX XX XX
① ②③④ ⑤ ⑥ ⑦ ⑧ ⑨

- ① Series No.
- ② Category: K-Cowfish Longhorn Connector
- ③ Welding Board Angle: V- Straight 180°
- ④ Welding Way: Blank-DIP
- ⑤ Row No.-Pin No.: 2*XX-Double Row
- ⑥ Plug the Pin & Special No.: B-With Convex platform
- ⑦ Material : 6T -PA6T 94V-0 ; 9T -PA9T 94V-0 ;
1T -PA10T 94V-0 ; 46 -PA46T 94V-0 ;
LP -LCP 94V-0
- ⑧ Planting Category: V01-All Gold Flash;
SN-Bright tin plating ;
- ⑨ Color: Blank-natural color

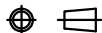
							<p>GENERAL TOLERANCE</p> <p>.X ±0.30</p> <p>.XX ±0.20</p> <p>.XXX ±0.10</p>				<p> 东莞市思量连接器有限公司</p> <p>DONGGUAN ADZL CONNECTORS CO.,LTD.</p>				<p>PART NO. 1276KV-2*XXB-XXXXX</p>			
							<p>APPROVAL</p> <p>Ken</p>				<p>CHECK</p> <p>Zhao Hong</p>							
							<p>DRAWN</p> <p>Allen</p>				<p>DATA</p> <p>2017/03/25</p>							
							<p>PROJECT</p> <p></p>				<p>UNIT</p> <p>MM</p>							
							<p>SCALE</p> <p>1 : 1</p>				<p>NUMBER</p>							
DATE	OLD REV	NEW REV	ECN	DESCRIPTION	CHECK	APPROVAL												

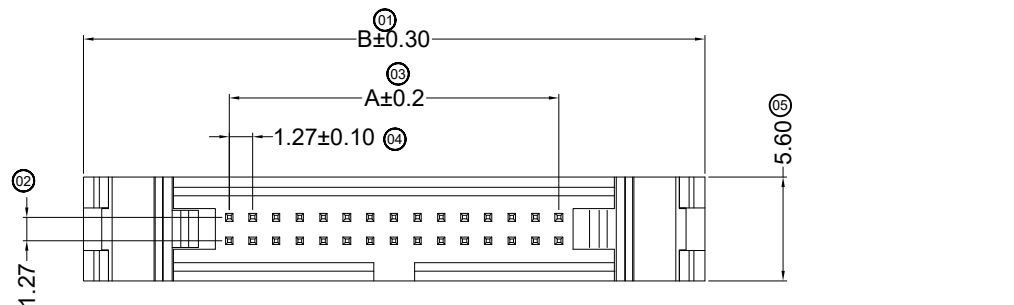

■ Specifications :

- Voltage rating: 250V AC / DC
- Current rating: 1A AC / DC
- Withstanding voltage: 500V AC/minute
- Temperature range: -25°C~+85°C
- Insulation resistance: ≥100MΩ
- Contact resistance: ≤30mΩ
- After environmental testing: ≤40mΩ
- Mates With ADZL Housing :1276HI

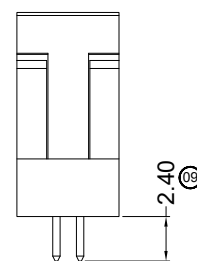
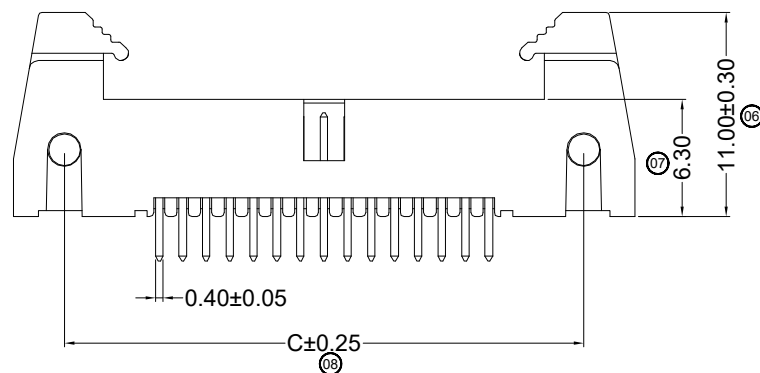

1276 K V X- 2*XX A-PT V01 XX
 ① ② ③④ ⑤ ⑥ ⑦ ⑧ ⑨

- ① Series No.
- ② Category: K-Cowfish Longhorn Connector
- ③ Welding Board Angle: V-180° ; R-90°
- ④ Welding Way: Blank-DIP ; S-SMT
- ⑤ Row No.-Pin No.: XX-Single Row ; 2*XX-Double Row
- ⑥ Plug the Pin & Special No. : A-Cowfish Longhorn with Lock
- ⑦ Material: PT-PBT 94V-0
- ⑧ Plating Category: Planting Category: V01-All Gold Flash; SN-Bright tin plating ;
- ⑨ Color: Blank-natural color

Poles	Dimensions (mm)		
	A	B	C
06	2.54	18.31	12.81
08	3.81	19.58	14.08
10	5.08	20.85	15.35
14	7.62	23.39	17.89
16	8.89	24.66	19.16
18	10.16	25.93	20.43
20	11.43	27.20	21.70
26	15.24	31.01	25.51
30	17.78	33.55	28.05
34	20.32	36.09	30.59
40	24.13	39.90	34.40
50	30.48	46.25	40.75
60	36.83	52.60	47.10
64	39.37	55.14	49.64
68	41.91	57.68	52.18

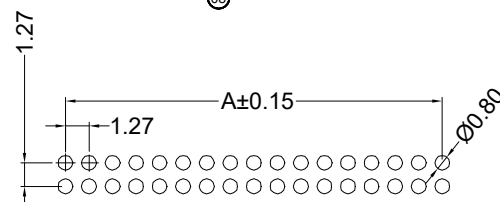

P.C.B Board Layout

DATE	OLD REV	NEW REV	ECN	DESCRIPTION	CHECK	APPROVAL

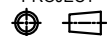
GENERAL TOLERANCE	
.X	±0.30
.XX	±0.20
.XXX	±0.10
PROJECT	

 东莞市思量连接器有限公司
 DONGGUAN ADZL CONNECTORS CO.,LTD.

APPROVAL	CHECK	DRAWN	DATA
Ken	Zhao Hong	Allen	2017/08/01

PART NO. 1276KV-2*XXA-PTXXX			
TITLE 1.27 mm Crimp Style Connector			
UNIT MM	SCALE 1 : 1	NUMBER	REV

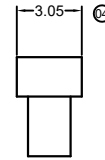
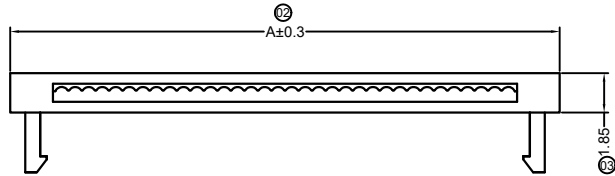
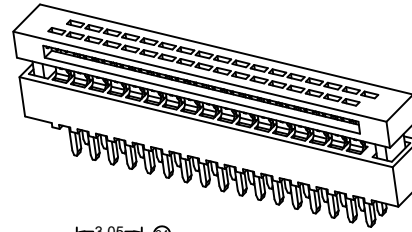

Specifications :

- Voltage rating: 250V AC / DC
- Current rating: 0.5A AC / DC
- Withstanding voltage: 250V AC/minute
- Temperature range: -25°C~+85°C
- Insulation resistance: ≥100MΩ
- Contact resistance: ≤30mΩ
- After environmental testing: ≤40mΩ

1276 H D V-2*XX X-PTB XX XX
 ① ② ③ ④ ⑤ ⑥ ⑦ ⑧ ⑨

- ① Series No.
- ② Category: H-HSG
- ③ Welding Way: D-DIP
- ④ Welding Board Angle: V-180°
- ⑤ Row No.-Pin No.: XX-04P~26P
- ⑥ Plug the Pin & special No.:
- ⑦ Material: PT-PBT 94V-0 B-Brass
- ⑧ Planting Category:
 G:Gold-Plated Contact *01-Gold Flash
 SN-Bright tin plating
- ⑨ Color: Blank-natural color

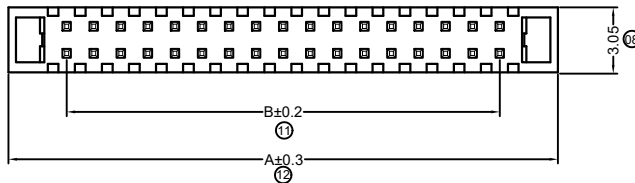
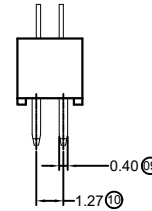
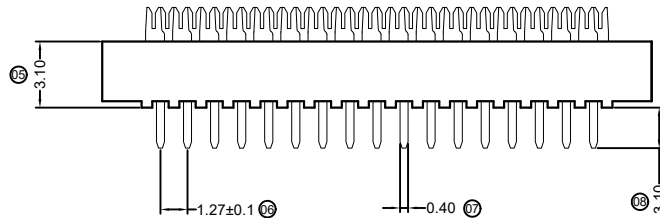

Poles	Dimensions(mm)		Poles	Dimensions(mm)	
	A	B		A	B
2*03	8.00	2.54	2*13	20.70	15.24
2*04	9.27	3.81	2*15	23.24	17.78
2*05	10.54	5.08	2*17	25.78	20.32
2*06	11.81	6.35	2*20	29.59	24.13
2*07	13.08	7.62	2*22	32.13	26.67
2*08	14.35	8.89	2*25	35.94	30.48
2*09	15.62	10.16	2*30	42.29	36.83
2*10	16.89	11.43	2*32	44.83	39.37

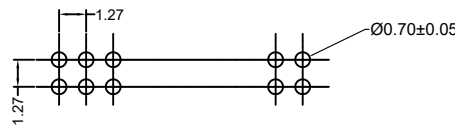

P.C.B LAYOUT

1276HDV-2*XX-PTBG01	PBT UL 94V-0	Brass	Contact Area Gold Flash
1276HDV-2*XX-PTBSN			Tin-Plated
PART NO	Material	Material(Pin)	Finish(Pin)

DATE	OLD REV	NEW REV	ECN	DESCRIPTION	CHECK	APPROVAL

GENERAL TOLERANCE	
.X	±0.30
.XX	±0.20
.XXX	±0.10

ADZL 东莞市思量连接器有限公司
 DONGGUAN ADZL CONNECTORS CO.,LTD.

APPROVAL	CHECK	DRAWN	DATA
Ken	Zhao Hong	Allen	2018/11/14

PART NO. 1276HDV-2*XX-PTBXX			
TITLE 1.27 mm Crimp Style Connectors			
UNIT MM	SCALE 1 : 1	NUMBER	REV

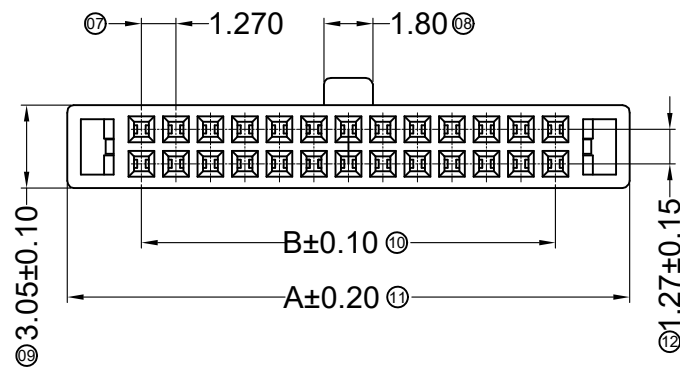
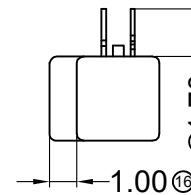
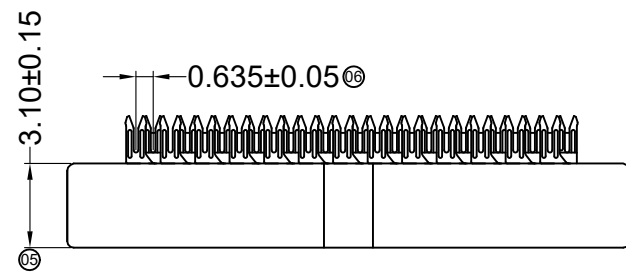
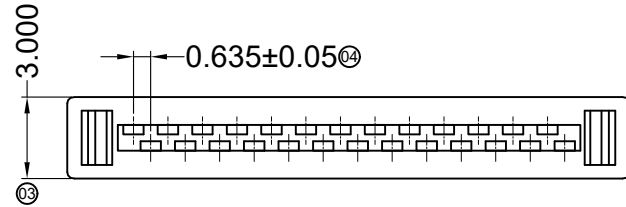
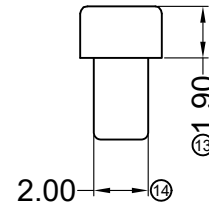
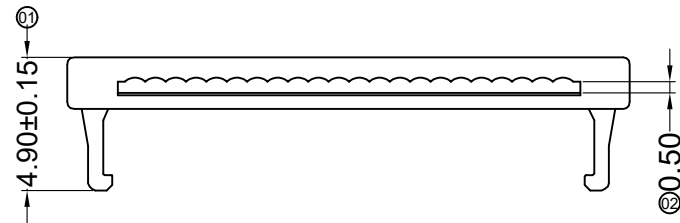

■ Specifications :

- Voltage rating: 250V AC / DC
- Current rating: 0.5A AC / DC
- Withstanding voltage: 500V AC/minute
- Temperature range: -25°C~+85°C
- Insulation resistance: ≥100MΩ
- Contact resistance: ≤30mΩ
- After environmental testing: ≤40mΩ

1276 H I-2*XX X-XX XX
① ②③ ④ ⑤ ⑥ ⑦

- ① Series No.
- ② Category: H-HSG
- ③ Appearance type:
I-HSG and Hardware assembly
- ④ Row No.-Pin No.: 2*XX-Double Row
- ⑤ Plug the Pin & special No.:
Blank-Two-Piece, Contact Gold Flash;
G15-Two-Piece, Contact Gold 15u";
G30-Two-Piece, Contact Gold 30u"
- ⑥ Material: 46-PA46 94V-0; PT-PBT UL 94V-0
- ⑦ Color: Blank : Natural Color

Poles	Dimensions (mm)		Poles	Dimensions (mm)		Poles	Dimensions (mm)	
	A	B		A	B		A	B
2*03	8.00	2.54	2*10	16.89	11.43	2*21	30.86	25.40
2*04	9.27	3.81	2*12	18.16	12.70	2*22	32.13	26.67
2*05	10.54	5.08	2*13	20.70	15.24	2*25	35.94	30.48
2*06	11.81	6.35	2*14	21.97	16.51	2*26	37.21	31.75
2*07	13.08	7.62	2*15	23.24	17.78	2*30	42.29	36.83
2*08	14.35	8.89	2*17	25.78	20.32	2*32	44.83	39.37
2*09	15.62	10.16	2*20	29.59	24.13			

GENERAL TOLERANCE
.X ±0.30
.XX ±0.20
.XXX ±0.10

 东莞市思量连接器有限公司
DONGGUAN ADZL CONNECTORS CO.,LTD.

PART NO.
1276HI-2*XXXX-XX

TITLE
1.27 mm Crimp Style Connector

APPROVAL CHECK DRAWN DATA

Ken Zhao Hong Allen 2017/08/01

UNIT SCALE NUMBER REV
MM 1 : 1

DATE	OLD REV	NEW REV	ECN	DESCRIPTION	CHECK	APPROVAL

PROJECT
