

Recommended P.C.B LAYOUT(Top Side)
(PCB BOARD TOLERANCE±0.05)

■ Specifications :

- Voltage rating: 500V AC / DC
- Current rating: 1A AC / DC
- Withstanding voltage: 1000V AC/minute
- Temperature range: -25°C~+85°C
- Insulation resistance: ≥1000MΩ
- Contact resistance: ≤20mΩ
- After environmental testing: ≤30mΩ

9127 W V X-XX A1-9T SN XX
① ② ③ ④ ⑤ ⑥ ⑦ ⑧ ⑨

- ① Series No.
- ② Category: W-wafer
- ③ Welding Board Angle: V- Straight 180°
- ④ Welding Way: Blank-DIP
- ⑤ Row No.-Pin No.: XX-04P~26P
- ⑥ Plug the Pin & Special No.: A1-Single Deficiency
- ⑦ Material: 9T-Nylon 9T 94V-0
- ⑧ Planting Category: SN-Bright tin plating
- ⑨ Color: RE-Red RD-purplish red

Poles	Dimensions(mm)			Poles	Dimensions(mm)		
	A	B	C		A	B	C
04	3.81	7.00	5.60	16	19.05	22.24	20.84
06	6.35	9.54	8.14	18	21.59	24.78	23.38
08	8.89	12.08	10.68	20	24.13	27.32	25.92
10	11.43	14.62	13.22	22	26.67	29.86	28.46
12	13.97	17.16	15.76	24	29.21	32.40	31.00
14	16.51	19.70	18.30	26	31.75	34.94	33.54

9127WV-XXA1-9TSNRD	Purplish red	PA9T UL 94V-0	Brass	Tin-Plated
9127WV-XXA1-9TSNRE	Red			
PART NO	Color	Material	Material(Pin)	Finish(Pin)

DATE	OLD REV	NEW REV	ECN	DESCRIPTION	CHECK	APPROVAL

GENERAL TOLERANCE
.X ±0.30
.XX ±0.20
.XXX ±0.10

 东莞市思量连接器有限公司
DONGGUAN ADZL CONNECTORS CO.,LTD.

APPROVAL	CHECK	DRAWN	DATA
Ken	Zhao Hong	Allen	2017/05/20

PART NO. 9127WV-XXA1-9TSNXX			
TITLE 1.27 mm Crimp Style Connectors			
UNIT MM	SCALE 1:1	NUMBER	REV

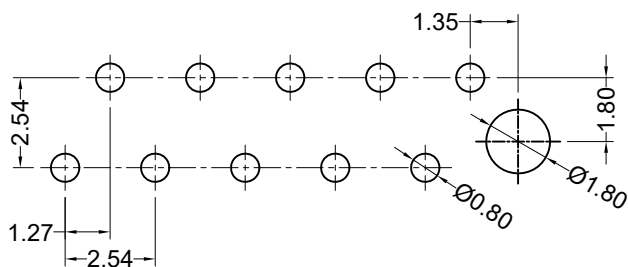
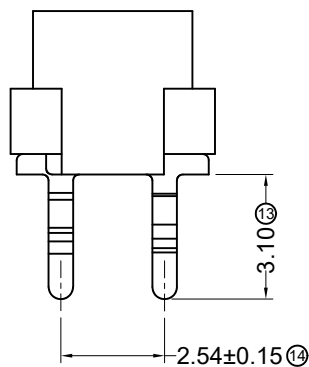
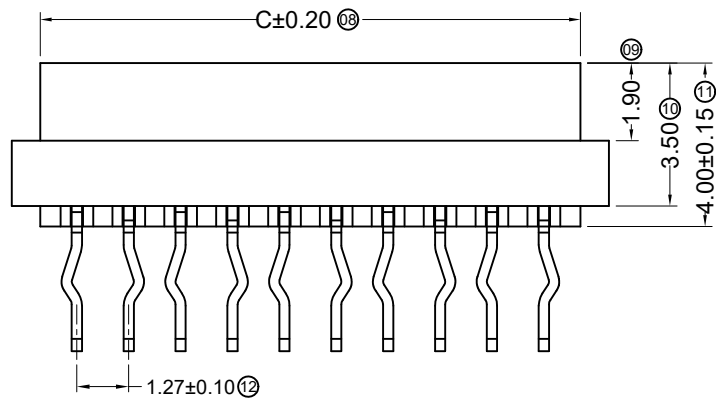
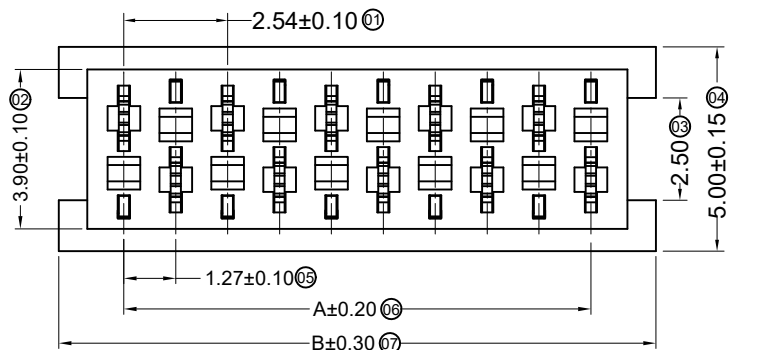

Recommended P.C.B LAYOUT(Top Side)
(PCB BOARD TOLERANCE±0.05)

■ Specifications :

- Voltage rating: 500V AC / DC
- Current rating: 1A AC / DC
- Withstanding voltage: 1000V AC/minute
- Temperature range: -25°C~+85°C
- Insulation resistance: ≥1000MΩ
- Contact resistance: ≤20mΩ
- After environmental testing: ≤30mΩ

9127 W V X-XX A2-9T SN XX
① ② ③ ④ ⑤ ⑥ ⑦ ⑧ ⑨

- ① Series No.
- ② Category: W-wafer
- ③ Welding Board Angle: V- Straight 180°
- ④ Welding Way: Blank-DIP
- ⑤ Row No.-Pin No.: XX-04P~26P
- ⑥ Plug the Pin & Special No.: A2-Double Deficiency
- ⑦ Material: 9T-Nylon 9T 94V-0
- ⑧ Planting Category: SN-Bright tin plating
- ⑨ Color: RE-Red RD-purplish red

Poles	Dimensions(mm)			Poles	Dimensions(mm)		
	A	B	C		A	B	C
04	3.81	7.00	5.60	16	19.05	22.24	20.84
06	6.35	9.54	8.14	18	21.59	24.78	23.38
08	8.89	12.08	10.68	20	24.13	27.32	25.92
10	11.43	14.62	13.22	22	26.67	29.86	28.46
12	13.97	17.16	15.76	24	29.21	32.40	31.00
14	16.51	19.70	18.30	26	31.75	34.94	33.54

9127WV-XXA2-9TSNRD	Purplish red	PA9T UL 94V-0	Brass	Tin-Plated
9127WV-XXA2-9TSNRE	Red			
PART NO	Color	Material	Material(Pin)	Finish(Pin)

DATE	OLD REV	NEW REV	ECN	DESCRIPTION	CHECK	APPROVAL

GENERAL TOLERANCE
.X ±0.30
.XX ±0.20
.XXX ±0.10

 东莞市思量连接器有限公司
DONGGUAN ADZL CONNECTORS CO.,LTD.

APPROVAL	CHECK	DRAWN	DATA
Ken	Zhao Hong	Allen	2011/06/23

PART NO. 9127WV-XXA2-9TSNXX
TITLE 1.27 mm Crimp Style Connectors
UNIT MM SCALE 1 : 1 NUMBER REV

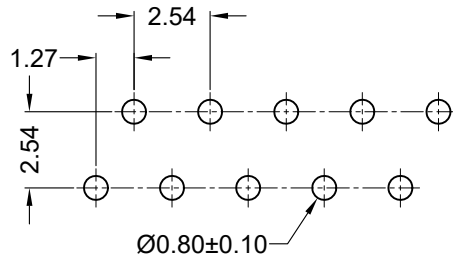
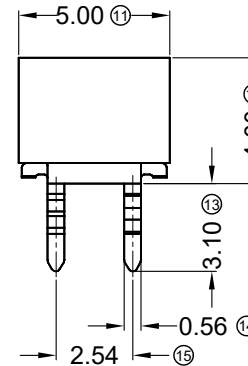
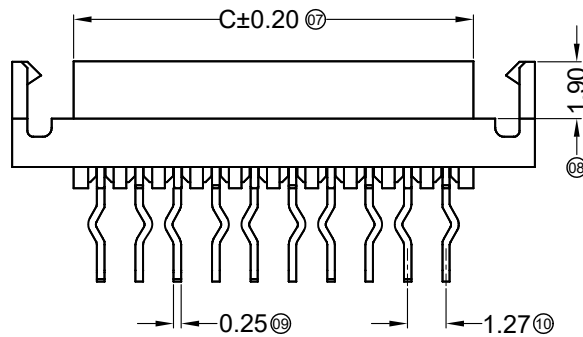
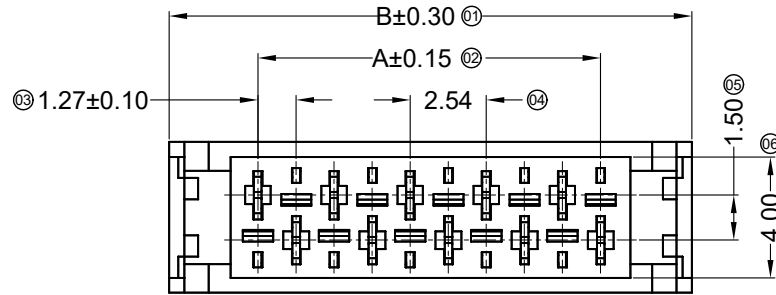

Recommended P.C.B Layout
General Tolerance±0.05

■ Specifications :

- Voltage rating: 500V AC / DC
- Current rating: 1A AC / DC
- Withstanding voltage: 1000V AC/minute
- Temperature range: -25°C~+85°C
- Insulation resistance: ≥1000MΩ
- Contact resistance: ≤20mΩ
- After environmental testing: ≤30mΩ

9127 W V X-XX B-9T SN XX
① ② ③ ④ ⑤ ⑥ ⑦ ⑧ ⑨

- ① Series No.
- ② Category: W-wafer
- ③ Welding Board Angle: V- Straight 180°
- ④ Welding Way: Blank-DIP
- ⑤ Row No.-Pin No.: XX-04P~26P
- ⑥ Plug the Pin & Special No.:
B-Without boss and tail, With Ear, Concave
- ⑦ Material: 9T-Nylon 9T 94V-0
- ⑧ Planting Category: SN-Bright tin plating
- ⑨ Color: RE-Red RD-purplish red

Poles	Dimensions(mm)		
	A	B	C
04	3.81	9.68	5.60
06	6.35	12.22	8.14
08	8.89	14.76	10.68
10	11.43	17.30	13.22
12	13.97	19.84	15.76
14	16.51	22.38	18.30
16	19.05	24.92	20.84
18	21.59	27.46	23.38
20	24.13	30.00	25.92
22	26.67	32.54	28.46
24	29.21	35.08	31.00
26	31.75	37.62	33.54

9127WV-XXB-9TSNRD	Purplish red	PA9T UL 94V-0	Brass	Tin-Plated
9127WV-XXB-9TSNRE	RED			
PART NO	Color	Material	Material(Pin)	Finish(Pin)

DATE	OLD REV	NEW REV	ECN	DESCRIPTION	CHECK	APPROVAL

GENERAL TOLERANCE	
.X	±0.30
.XX	±0.20
.XXX	±0.10

ADZL 东莞市思量连接器有限公司
DONGGUAN ADZL CONNECTORS CO.,LTD.

APPROVAL	CHECK	DRAWN	DATA
Ken	Zhao Hong	Allen	2017/07/04

PART NO. 9127WV-XXB-9TSNXX			
TITLE 1.27 mm Crimp Style Connectors			
UNIT MM	SCALE 1:1	NUMBER	REV

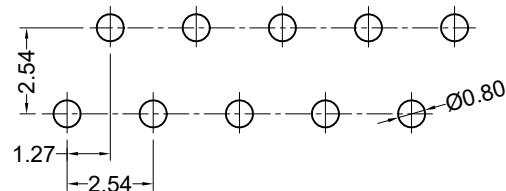
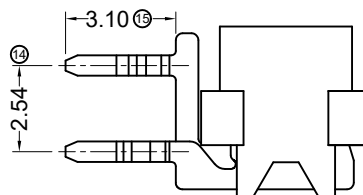
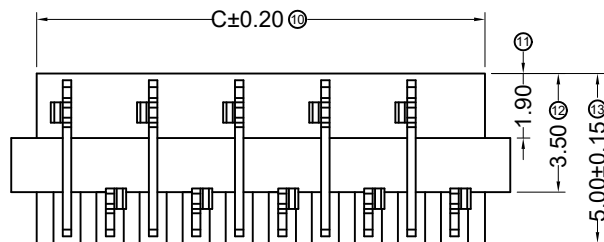
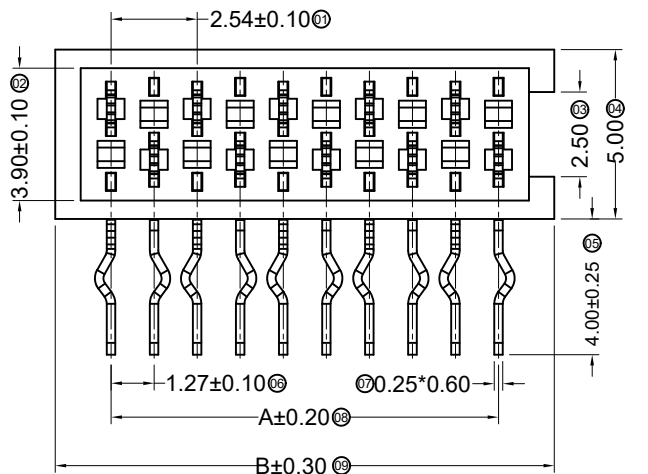

Recommended P.C.B Layout(Top Side)
(PCB BOARD TOLERANCE±0.05)

Specifications :

- Voltage rating: 500V AC / DC
- Current rating: 1A AC / DC
- Withstanding voltage: 1000V AC/minute
- Temperature range: -25°C~+85°C
- Insulation resistance: ≥1000MΩ
- Contact resistance: ≤20mΩ
- After environmental testing: ≤30mΩ

9127 W R X-XX A1-9T SN XX
① ② ③ ④ ⑤ ⑥ ⑦ ⑧ ⑨

- ① Series No.
- ② Category: W-wafer
- ③ Welding Board Angle: R-Right Angle 90°
- ④ Welding Way: Blank-DIP
- ⑤ Row No.-Pin No.: XX-04P~26P
- ⑥ Plug the Pin & Special No.:
A1-Without Ear and boss、With tail and Single Concave
- ⑦ Material: 9T-Nylon 9T 94V-0
- ⑧ Planting Category: SN-Bright tin plating
- ⑨ Color: RE-Red RD-purplish red

Poles	Dimensions(mm)			Poles	Dimensions(mm)		
	A	B	C		A	B	C
04	3.81	7.00	5.60	16	19.05	22.24	20.84
06	6.35	9.54	8.14	18	21.59	24.78	23.38
08	8.89	12.08	10.68	20	24.13	27.32	25.92
10	11.43	14.62	13.22	22	26.67	29.86	28.46
12	13.97	17.16	15.76	24	29.21	32.40	31.00
14	16.51	19.70	18.30	26	31.75	34.94	33.54

9127WR-XXA1-9TSNRD	Purplish red	PA9T UL 94V-0	Brass	Tin-Plated
9127WR-XXA1-9TSNRE	Red			
PART NO	Color	Material	Material(Pin)	Finish(Pin)

DATE	OLD REV	NEW REV	ECN	DESCRIPTION	CHECK	APPROVAL

GENERAL TOLERANCE	
.X	±0.30
.XX	±0.20
.XXX	±0.10

 东莞市思量连接器有限公司
DONGGUAN ADZL CONNECTORS CO.,LTD.

APPROVAL	CHECK	DRAWN	DATA
Ken	Zhao Hong	Allen	2017/10/07

PART NO. 9127WR-XXA1-9TSNXX			
TITLE 1.27 mm Crimp Style Connectors			
UNIT MM	SCALE 1:1	NUMBER	REV

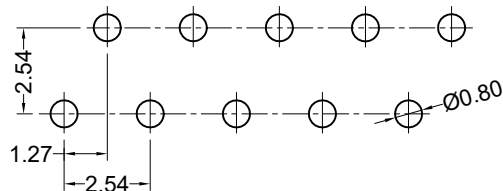
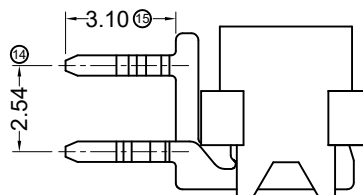
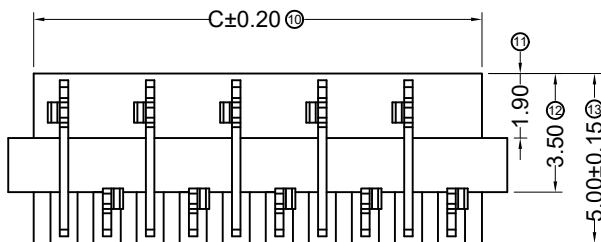
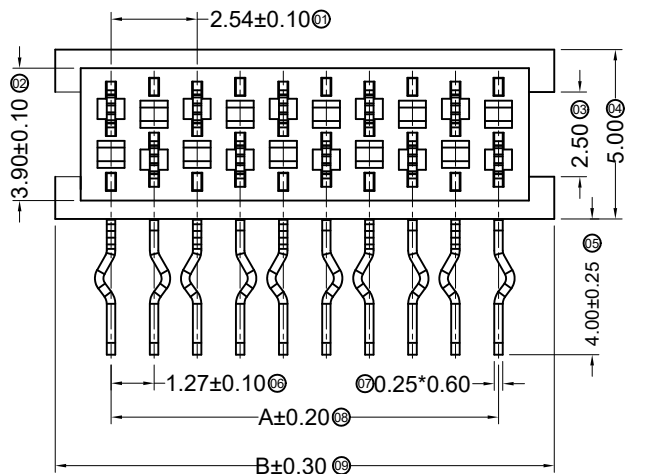

Recommended P.C.B Layout(Top Side)
(PCB BOARD TOLERANCE±0.05)

■ Specifications :

- Voltage rating: 500V AC / DC
- Current rating: 1A AC / DC
- Withstanding voltage: 1000V AC/minute
- Temperature range: -25°C~+85°C
- Insulation resistance: ≥1000MΩ
- Contact resistance: ≤20mΩ
- After environmental testing: ≤30mΩ

9127 W R X-XX A2-9T SN XX

① ② ③ ④ ⑤ ⑥ ⑦ ⑧ ⑨

- ① Series No.
- ② Category: W-wafer
- ③ Welding Board Angle: R-Right Angle 90°
- ④ Welding Way: Blank-DIP
- ⑤ Row No.-Pin No.: XX-04P~26P
- ⑥ Plug the Pin & Special No.:
A2-Without Ear and boss、With tail and Concave
- ⑦ Material: 9T-Nylon 9T 94V-0
- ⑧ Planting Category: SN-Bright tin plating
- ⑨ Color: RE-Red RD-purplish red

Poles	Dimensions(mm)			Poles	Dimensions(mm)		
	A	B	C		A	B	C
04	3.81	7.00	5.60	16	19.05	22.24	20.84
06	6.35	9.54	8.14	18	21.59	24.78	23.38
08	8.89	12.08	10.68	20	24.13	27.32	25.92
10	11.43	14.62	13.22	22	26.67	29.86	28.46
12	13.97	17.16	15.76	24	29.21	32.40	31.00
14	16.51	19.70	18.30	26	31.75	34.94	33.54

9127WR-XXA2-9TSNRD	Purplish red	PA9T UL 94V-0	Brass	Tin-Plated
9127WR-XXA2-9TSNRE	Red			
PART NO	Color	Material	Material(Pin)	Finish(Pin)

DATE	OLD REV	NEW REV	ECN	DESCRIPTION	CHECK	APPROVAL

GENERAL TOLERANCE	
.X	±0.30
.XX	±0.20
.XXX	±0.10

 东莞市思量连接器有限公司
DONGGUAN ADZL CONNECTORS CO.,LTD.

APPROVAL	CHECK	DRAWN	DATA
Ken	Zhao Hong	Allen	2017/10/07

PART NO. 9127WR-XXA2-9TSNXX			
TITLE 1.27 mm Crimp Style Connectors			
UNIT MM	SCALE 1:1	NUMBER	REV

■ Specifications :

- Voltage rating: 500V AC / DC
- Current rating: 1A AC / DC
- Withstanding voltage: 1000V AC/minute
- Temperature range: -25°C~+85°C
- Insulation resistance: ≥1000MΩ
- Contact resistance: ≤20mΩ
- After environmental testing: ≤30mΩ

9127 W R X-XX A3-9T SN XX

① ② ③ ④ ⑤ ⑥ ⑦ ⑧ ⑨

- ① Series No.
- ② Category: W-wafer
- ③ Welding Board Angle: R-Right Angle 90°
- ④ Welding Way: Blank-DIP
- ⑤ Row No.-Pin No.: XX-04P~26P
- ⑥ Plug the Pin & Special No.:
A3-Without Ear and boss、With tail and Left Concave
- ⑦ Material: 9T-Nylon 9T 94V-0
- ⑧ Planting Category: SN-Bright tin plating
- ⑨ Color: RE-Red RD-purplish red

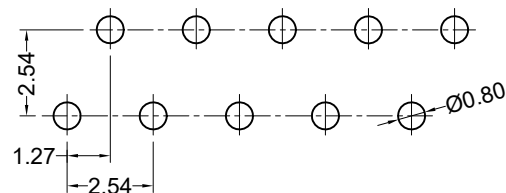
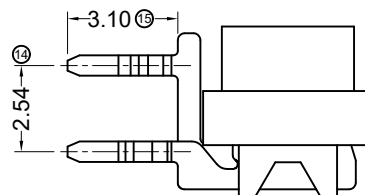
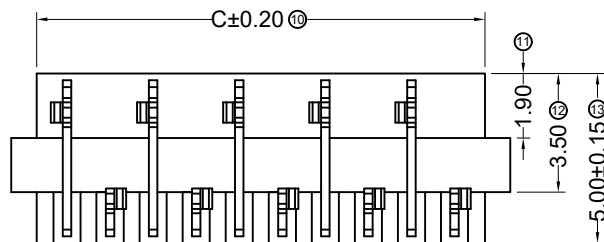
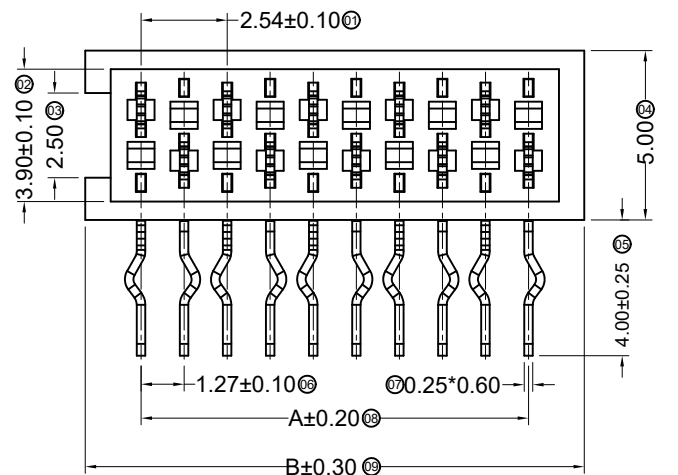

Recommended P.C.B Layout(Top Side)
(PCB BOARD TOLERANCE±0.05)

Poles	Dimensions(mm)			Poles	Dimensions(mm)		
	A	B	C		A	B	C
04	3.81	7.00	5.60	16	19.05	22.24	20.84
06	6.35	9.54	8.14	18	21.59	24.78	23.38
08	8.89	12.08	10.68	20	24.13	27.32	25.92
10	11.43	14.62	13.22	22	26.67	29.86	28.46
12	13.97	17.16	15.76	24	29.21	32.40	31.00
14	16.51	19.70	18.30	26	31.75	34.94	33.54

9127WR-XXA3-9TSNRD	Purplish red	PA9T UL 94V-0	Brass	Tin-Plated
9127WR-XXA3-9TSNRE	Red			
PART NO	Color	Material	Material(Pin)	Finish(Pin)

DATE	OLD REV	NEW REV	ECN	DESCRIPTION	CHECK	APPROVAL

GENERAL TOLERANCE
.X ±0.30
.XX ±0.20
.XXX ±0.10

PROJECT

 东莞市思量连接器有限公司
DONGGUAN ADZL CONNECTORS CO.,LTD.

APPROVAL	CHECK	DRAWN	DATA
Ken	Zhao Hong	Allen	2014/10/31

PART NO. 9127WR-XXA3-9TSNXX			
TITLE 1.27 mm Crimp Style Connectors			
UNIT MM	SCALE 1:1	NUMBER	REV

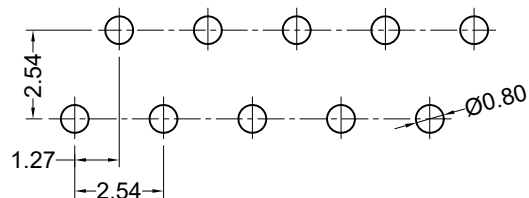
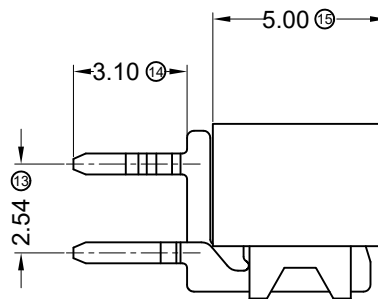
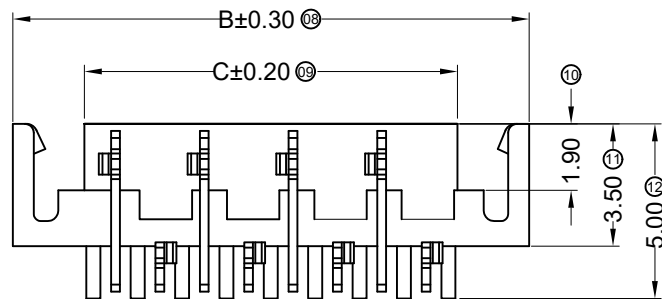
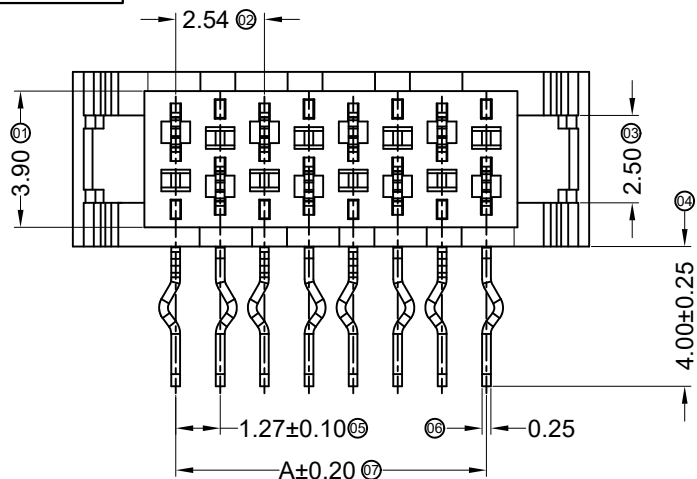

Recommended PCB Layout(Top Side)
(PCB Board Tolerance±0.05)

Specifications :

- Voltage rating: 500V AC / DC
- Current rating: 1A AC / DC
- Withstanding voltage: 1000V AC/minute
- Temperature range: -25°C~+85°C
- Insulation resistance: ≥1000MΩ
- Contact resistance: ≤20mΩ
- After environmental testing: ≤30mΩ

9127 W R X-XX B3-9T SN XX
① ② ③ ④ ⑤ ⑥ ⑦ ⑧ ⑨

- ① Series No.
- ② Category: W-wafer
- ③ Welding Board Angle: R-Right Angle 90°
- ④ Welding Way: Blank-DIP
- ⑤ Row No.-Pin No.: XX-04P~26P
- ⑥ Plug the Pin & Special No.:
B3-With boss、tail、Ear、Double Concave
- ⑦ Material: 9T-Nylon 9T 94V-0
- ⑧ Planting Category: SN-Bright tin plating
- ⑨ Color: RE-Red RD-purplish red

Poles	Dimensions(mm)			Poles	Dimensions(mm)		
	A	B	C		A	B	C
4	3.81	9.70	5.60	16	19.05	24.94	20.84
6	6.35	12.24	8.14	18	21.59	27.48	23.38
8	8.89	14.78	10.68	20	24.13	30.02	25.92
10	11.43	17.32	13.22	22	26.67	32.56	28.46
12	13.97	19.86	15.76	24	29.21	35.10	31.00
14	16.51	22.40	18.30	26	31.75	37.64	33.54

9127WR-XXB3-9TSNRD	Purplish red	PA9T UL 94V-0	Brass	Tin-Plated
9127WR-XXB3-9TSNRE	RED			
PART NO	Color	Material	Material(Pin)	Finish(Pin)

DATE	OLD REV	NEW REV	ECN	DESCRIPTION	CHECK	APPROVAL

GENERAL TOLERANCE	
.X	±0.30
.XX	±0.20
.XXX	±0.10

 东莞市思量连接器有限公司
DONGGUAN ADZL CONNECTORS CO.,LTD.

APPROVAL	CHECK	DRAWN	DATA
Ken	Zhao Hong	Allen	2017/07/07

PART NO. 9127WR-XXB3-9TSNXX			
TITLE 1.27 mm Crimp Style Connectors			
UNIT MM	SCALE 1 : 1	NUMBER	REV

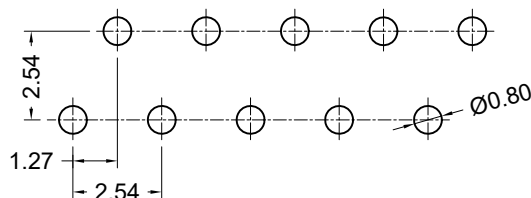
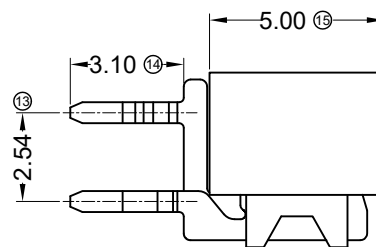
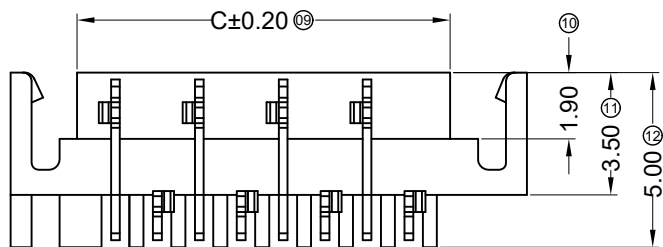
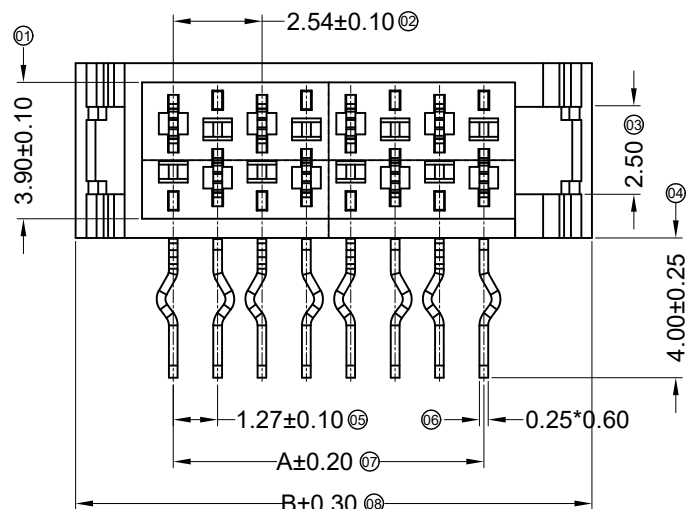

Recommended P.C.B Layout(Top Side)
(PCB BOARD TOLERANCE±0.05)

Specifications :

- Voltage rating: 500V AC / DC
- Current rating: 1A AC / DC
- Withstanding voltage: 1000V AC/minute
- Temperature range: -25°C~+85°C
- Insulation resistance: ≥1000MΩ
- Contact resistance: ≤20mΩ
- After environmental testing: ≤30mΩ

9127 W R X-XX B4-9T SN XX

① ② ③ ④ ⑤ ⑥ ⑦ ⑧ ⑨

- ① Series No.
- ② Category: W-wafer
- ③ Welding Board Angle: R-Right Angle 90°
- ④ Welding Way: Blank-DIP
- ⑤ Row No.-Pin No.: XX-04P~26P
- ⑥ Plug the Pin & Special No.:
B4-With boss, tail, Ear, Single Concave
- ⑦ Material: 9T-Nylon 9T 94V-0
- ⑧ Planting Category: SN-Bright tin plating
- ⑨ Color: RE-Red RD-purplish red

Poles	Dimensions(mm)			Poles	Dimensions(mm)		
	A	B	C		A	B	C
4	3.81	9.70	5.60	16	19.05	24.94	20.84
6	6.35	12.24	8.14	18	21.59	27.48	23.38
8	8.89	14.78	10.68	20	24.13	30.02	25.92
10	11.43	17.32	13.22	22	26.67	32.56	28.46
12	13.97	19.86	15.76	24	29.21	35.10	31.00
14	16.51	22.40	18.30	26	31.75	37.64	33.54

9127WR-XXB4-9TSNRD	Purplish red	PA9T UL 94V-0	Brass	Tin-Plated
9127WR-XXB4-9TSNRE	RED			
PART NO	Color	Material	Material(Pin)	Finish(Pin)

DATE	OLD REV	NEW REV	ECN	DESCRIPTION	CHECK	APPROVAL

GENERAL TOLERANCE
.X ±0.30
.XX ±0.20
.XXX ±0.10

 东莞市思量连接器有限公司
DONGGUAN ADZL CONNECTORS CO.,LTD.

APPROVAL	CHECK	DRAWN	DATA
Ken	Zhao Hong	Allen	2017/07/04

PART NO. 9127WR-XXB4-9TSNXX
TITLE 1.27 mm Crimp Style Connectors
UNIT MM SCALE 1:1 NUMBER REV

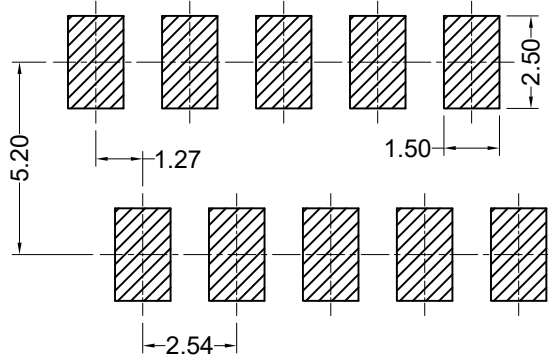
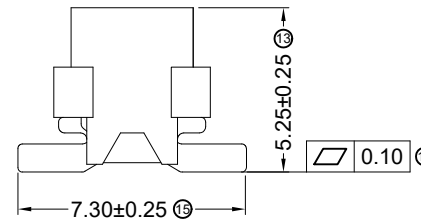
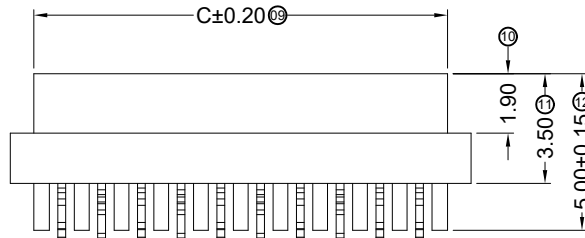
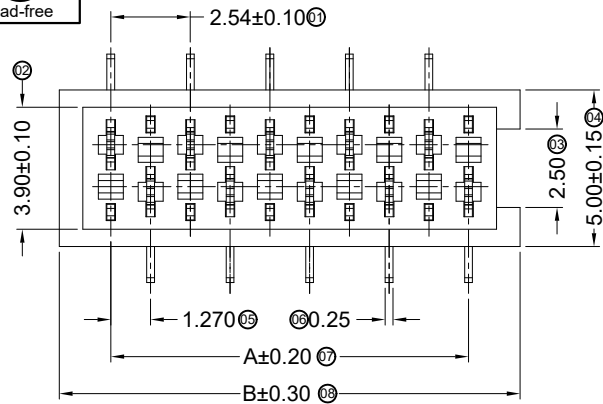

Recommended PCB Layout(Top Side)
(PCB Board Tolerance±0.05)

■ Specifications :

- Voltage rating: 500V AC / DC
- Current rating: 1A AC / DC
- Withstanding voltage: 500V AC/minute
- Temperature range: -25°C~+85°C
- Insulation resistance: ≥1000MΩ
- Contact resistance: ≤10mΩ
- After environmental testing: ≤20mΩ

9127 W V S-XX A1-9T SN XX

① ② ③ ④ ⑤ ⑥ ⑦ ⑧ ⑨

- ① Series No.
- ② Category: W-wafer
- ③ Welding Board Angle: V- Straight 180°
- ④ Welding Way: S-SMT
- ⑤ Row No.-Pin No.: XX-04P~26P
- ⑥ Plug the Pin & Special No.: A1-With Single Gap
- ⑦ Material: 9T-Nylon 9T 94V-0
- ⑧ Planting Category: SN-Bright tin plating
- ⑨ Color: RE-Red RD-purplish red

Poles	Dimensions(mm)			Poles	Dimensions(mm)		
	A	B	C		A	B	C
04	3.81	7.00	5.60	16	19.05	22.24	20.84
06	6.35	9.54	8.14	18	21.59	24.78	23.38
08	8.89	12.08	10.68	20	24.13	27.32	25.92
10	11.43	14.62	13.22	22	26.67	29.86	28.46
12	13.97	17.16	15.76	24	29.21	32.40	31.00
14	16.51	19.70	18.30	26	31.75	34.94	33.54

9127WVS-XXA1-9TSNRD	Purplish red	PA9T UL 94V-0	Brass	Tin-Plated
9127WVS-XXA1-9TSNRE	RED			
PART NO	Color	Material	Material(Pin)	Finish(Pin)

DATE	OLD REV	NEW REV	ECN	DESCRIPTION	CHECK	APPROVAL

GENERAL TOLERANCE	
.X	±0.30
.XX	±0.20
.XXX	±0.10

 东莞市思量连接器有限公司
DONGGUAN ADZL CONNECTORS CO.,LTD.

APPROVAL	CHECK	DRAWN	DATA
Ken	Zhao Hong	Allen	2018/07/04

PART NO. 9127WVS-XXA1-9TSNXX			
TITLE 1.27mm BTB Style Connectors			
UNIT MM	SCALE 1:1	NUMBER	REV



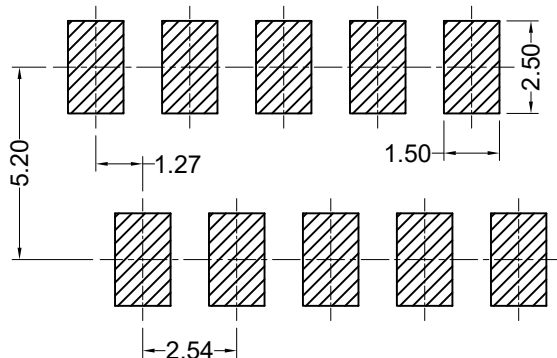
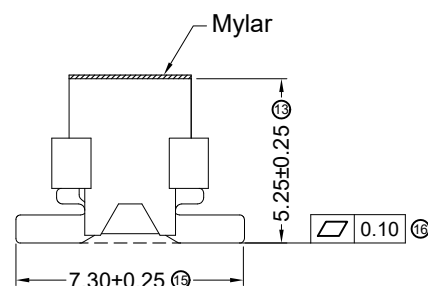
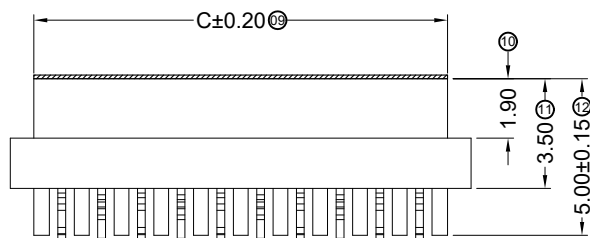
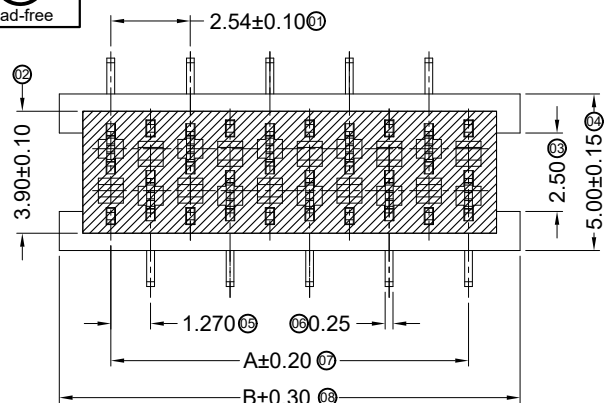

Recommended PCB Layout(Top Side)
(PCB Board Tolerance±0.05)

Specifications :

- Voltage rating: 500V AC / DC
- Current rating: 1A AC / DC
- Withstanding voltage: 500V AC/minute
- Temperature range: -25°C~+85°C
- Insulation resistance: ≥1000MΩ
- Contact resistance: ≤10mΩ
- After environmental testing: ≤20mΩ

9127 W V S-XX A2-9T SN XX
① ② ③ ④ ⑤ ⑥ ⑦ ⑧ ⑨

- ① Series No.
- ② Category: W-wafer
- ③ Welding Board Angle: V- Straight 180°
- ④ Welding Way: S-SMT
- ⑤ Row No.-Pin No.: XX-04P~26P
- ⑥ Plug the Pin & Special No.: A2-With Double Gap
- ⑦ Material: 9T-Nylon 9T 94V-0
- ⑧ Planting Category: SN-Bright tin plating
- ⑨ Color: RE-Red RD-purplish red

Poles	Dimensions(mm)			Poles	Dimensions(mm)		
	A	B	C		A	B	C
04	3.81	7.00	5.60	16	19.05	22.24	20.84
06	6.35	9.54	8.14	18	21.59	24.78	23.38
08	8.89	12.08	10.68	20	24.13	27.32	25.92
10	11.43	14.62	13.22	22	26.67	29.86	28.46
12	13.97	17.16	15.76	24	29.21	32.40	31.00
14	16.51	19.70	18.30	26	31.75	34.94	33.54

9127WVS-XXA2-9TSNRD	Purplish red	PA9T UL 94V-0	Brass	Tin-Plated
9127WVS-XXA2-9TSNRE	RED			
PART NO	Color	Material	Material(Pin)	Finish(Pin)

DATE	OLD REV	NEW REV	ECN	DESCRIPTION	CHECK	APPROVAL

GENERAL TOLERANCE	
.X	±0.30
.XX	±0.20
.XXX	±0.10

ADZL 东莞市思量连接器有限公司
DONGGUAN ADZL CONNECTORS CO.,LTD.

APPROVAL	CHECK	DRAWN	DATA
Ken	Zhao Hong	Allen	2017/07/04

PART NO. 9127WVS-XXA2-9TSNXX			
TITLE 1.27 mm Crimp Style Connectors			
UNIT MM	SCALE 1:1	NUMBER	REV

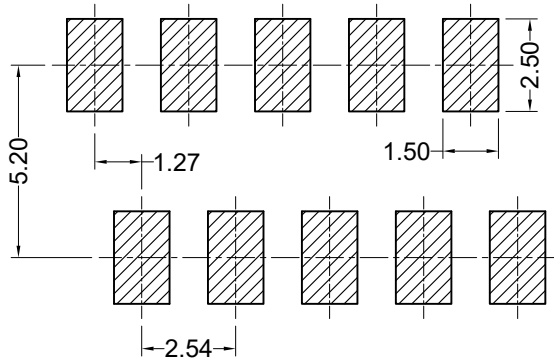
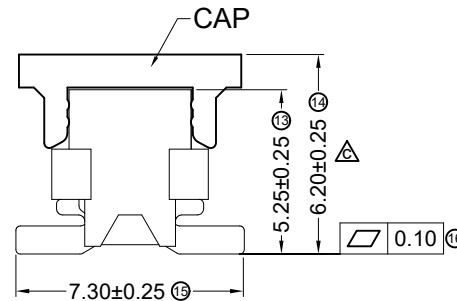
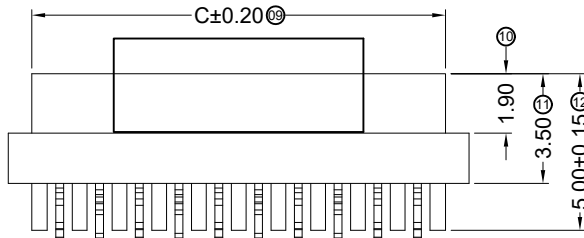
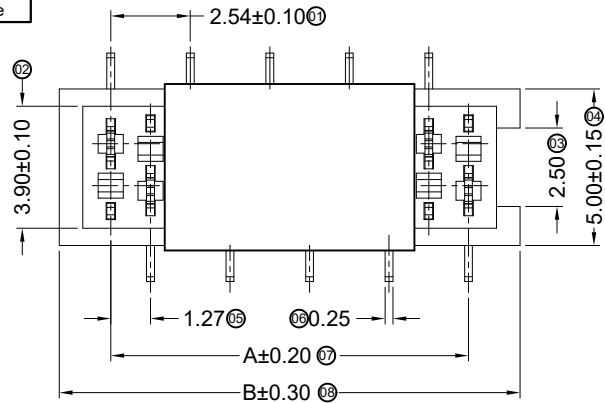

Recommended PCB Layout(Top Side)
(PCB Board Tolerance±0.05)

Specifications :

- Voltage rating: 500V AC / DC
- Current rating: 1A AC / DC
- Withstanding voltage: 500V AC/minute
- Temperature range: -25°C~+85°C
- Insulation resistance: ≥1000MΩ
- Contact resistance: ≤10mΩ
- After environmental testing: ≤20mΩ

9127 W V S-XX AC-9T SN XX
① ② ③ ④ ⑤ ⑥ ⑦ ⑧ ⑨

- ① Series No.
- ② Category: W-wafer
- ③ Welding Board Angle: V- Straight 180°
- ④ Welding Way: S-SMT
- ⑤ Row No.-Pin No.: XX-04P~26P
- ⑥ Plug the Pin & Special No.:
AC-With Single Gap and Cap
- ⑦ Material: 9T-Nylon 9T 94V-0
- ⑧ Planting Category: SN-Bright tin plating
- ⑨ Color: RE-Red RD-purplish red

Poles	Dimensions(mm)			Poles	Dimensions(mm)		
	A	B	C		A	B	C
04	3.81	7.00	5.60	16	19.05	22.24	20.84
06	6.35	9.54	8.14	18	21.59	24.78	23.38
08	8.89	12.08	10.68	20	24.13	27.32	25.92
10	11.43	14.62	13.22	22	26.67	29.86	28.46
12	13.97	17.16	15.76	24	29.21	32.40	31.00
14	16.51	19.70	18.30	26	31.75	34.94	33.54

9127WVS-XXAC-9TSNRD	Purplish red	PA9T UL 94V-0	Brass	Tin-Plated
9127WVS-XXAC-9TSNRE	RED			
PART NO	Color	Material	Material(Pin)	Finish(Pin)

DATE	OLD REV	NEW REV	ECN	DESCRIPTION	CHECK	APPROVAL

GENERAL TOLERANCE
.X ±0.30
.XX ±0.20
.XXX ±0.10



 东莞市思量连接器有限公司
DONGGUAN ADZL CONNECTORS CO.,LTD.

APPROVAL	CHECK	DRAWN	DATA
Ken	Zhao Hong	Allen	2017/07/04

PART NO. 9127WVS-XXAC-9TSNXX			
TITLE 1.27 mm Crimp Style Connectors			
UNIT MM	SCALE 1:1	NUMBER	REV

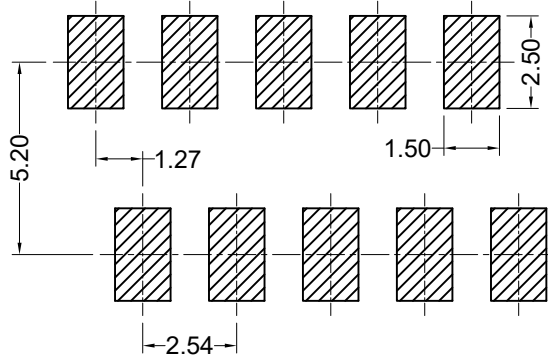
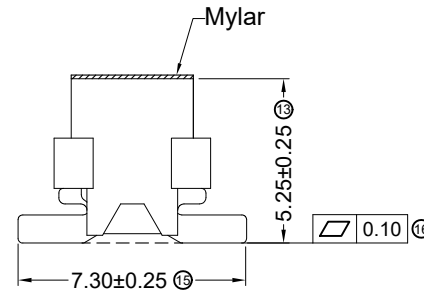
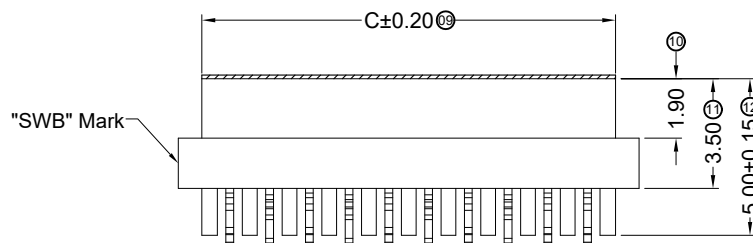
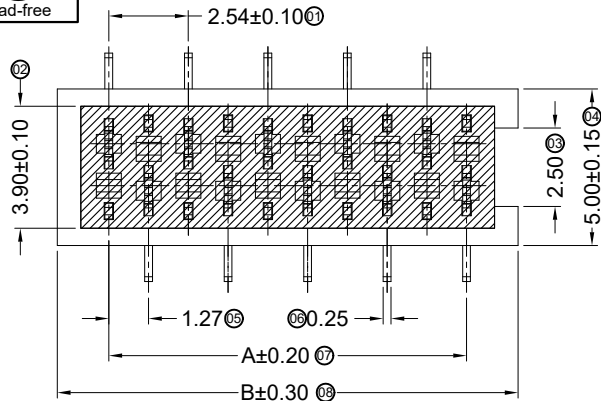

Recommended PCB Layout(Top Side)
(PCB Board Tolerance±0.05)

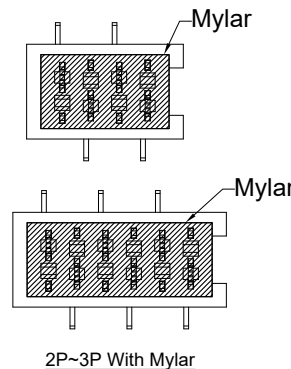

■ Specifications :

- Voltage rating: 500V AC / DC
- Current rating: 1A AC / DC
- Withstanding voltage: 500V AC/minute
- Temperature range: -25°C~+85°C
- Insulation resistance: ≥1000MΩ
- Contact resistance: ≤10mΩ
- After environmental testing: ≤20mΩ

9127 W V S-XX AM-9T SN XX

① ② ③ ④ ⑤ ⑥ ⑦ ⑧ ⑨

- ① Series No.
- ② Category: W-wafer
- ③ Welding Board Angle: V- Straight 180°
- ④ Welding Way: S-SMT
- ⑤ Row No.-Pin No.: XX-04P~26P
- ⑥ Plug the Pin & Special No.:
AM-With Single Gap and Mylar
- ⑦ Material: 9T-Nylon 9T 94V-0
- ⑧ Planting Category: SN-Bright tin plating
- ⑨ Color: RE-Red RD-purplish red

Poles	Dimensions(mm)			Poles	Dimensions(mm)		
	A	B	C		A	B	C
04	3.81	7.00	5.60	16	19.05	22.24	20.84
06	6.35	9.54	8.14	18	21.59	24.78	23.38
08	8.89	12.08	10.68	20	24.13	27.32	25.92
10	11.43	14.62	13.22	22	26.67	29.86	28.46
12	13.97	17.16	15.76	24	29.21	32.40	31.00
14	16.51	19.70	18.30	26	31.75	34.94	33.54

9127WVS-XXAM-9TSNRD	Purplish red	PA9T UL 94V-0	Brass	Tin-Plated
9127WVS-XXAM-9TSNRE	RED			
PART NO	Color	Material	Material(Pin)	Finish(Pin)

DATE	OLD REV	NEW REV	ECN	DESCRIPTION	CHECK	APPROVAL

GENERAL TOLERANCE

.X	±0.30
.XX	±0.20
.XXX	±0.10



 东莞市思量连接器有限公司
DONGGUAN ADZL CONNECTORS CO.,LTD.

APPROVAL	CHECK	DRAWN	DATA
Ken	Zhao Hong	Allen	2017/07/04

PART NO. 9127WVS-XXAM-9TSNXX			
TITLE 1.27 mm Crimp Style Connectors			
UNIT MM	SCALE 1:1	NUMBER	REV

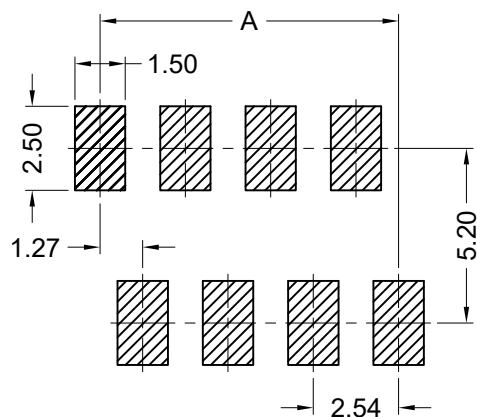
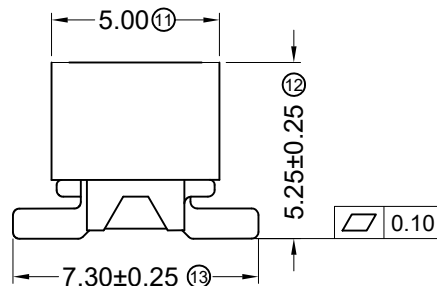
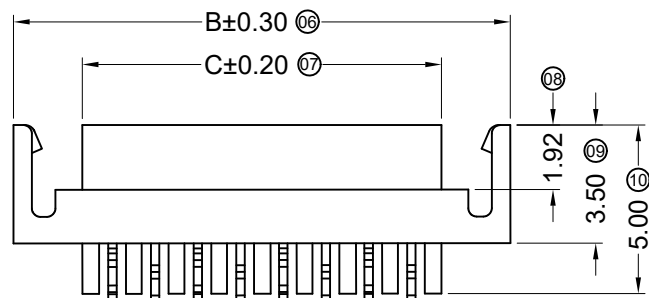
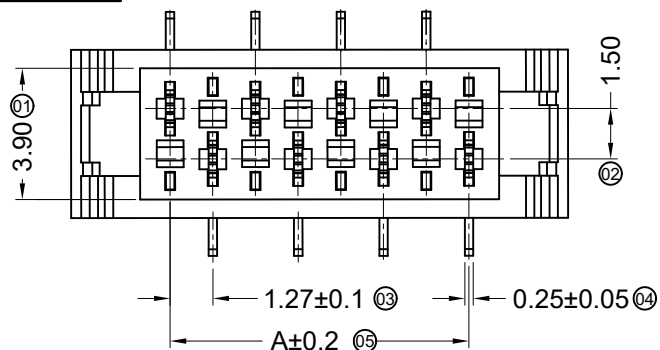

Recommended PCB Layout (Top Side)
(PCB Board Tolerance ±0.05)

Specifications :

- Voltage rating: 500V AC / DC
- Current rating: 1A AC / DC
- Withstanding voltage: 500V AC/minute
- Temperature range: -25°C~+85°C
- Insulation resistance: ≥1000MΩ
- Contact resistance: ≤10mΩ
- After environmental testing: ≤20mΩ

9127 W V S-XX B2-9T SN XX
① ② ③ ④ ⑤ ⑥ ⑦ ⑧ ⑨

- ① Series No.
- ② Category: W-wafer
- ③ Welding Board Angle: V- Straight 180°
- ④ Welding Way: S-SMT
- ⑤ Row No.-Pin No.: XX-04P~26P
- ⑥ Plug the Pin & Special No.:
B2-With Ear, Concave
- ⑦ Material: 9T-Nylon 9T 94V-0
- ⑧ Planting Category: SN-Bright tin plating
- ⑨ Color: RE-Red RD-purplish red

Poles	Dimensions(mm)			Poles	Dimensions(mm)		
	A	B	C		A	B	C
04	3.81	9.70	5.50	16	19.05	24.94	20.74
06	6.35	12.24	8.04	18	21.59	27.48	23.28
08	8.89	14.78	10.58	20	24.13	30.02	25.82
10	11.43	17.32	13.12	22	26.67	32.56	28.36
12	13.97	19.86	15.66	24	29.21	35.10	30.90
14	16.51	22.40	18.20	26	31.75	37.64	33.44

9127WVS-XXB2-9TSNRD	Purplish red	PA9T UL 94V-0	Brass	Tin-Plated
9127WVS-XXB2-9TSNRE	RED			
PART NO	Color	Material	Material(Pin)	Finish(Pin)

DATE	OLD REV	NEW REV	ECN	DESCRIPTION	CHECK	APPROVAL

GENERAL TOLERANCE	
.X	±0.30
.XX	±0.20
.XXX	±0.10



APPROVAL	CHECK	DRAWN	DATA
Ken	Zhao Hong	Allen	2017/07/04

PART NO. 9127WVS-XXB2-9TSNXX			
TITLE 1.27 mm Crimp Style Connectors			
UNIT MM	SCALE 1:1	NUMBER	REV

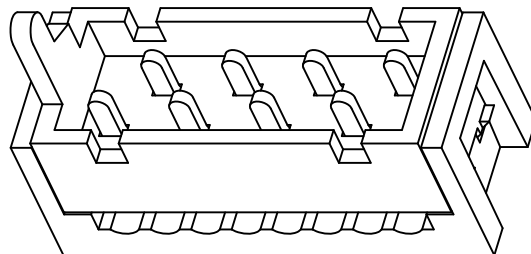
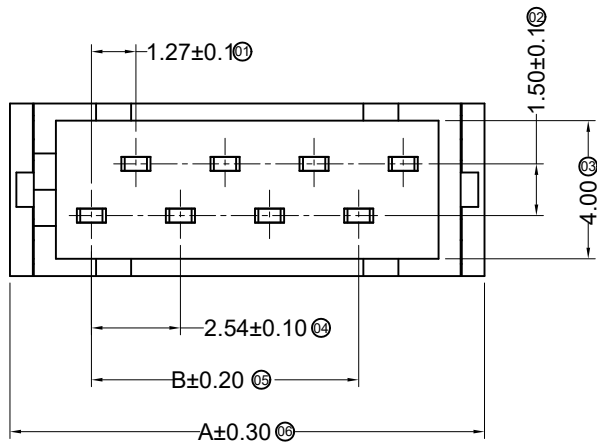

■ Specifications :

- Voltage rating: 500V AC / DC
- Current rating: 1A AC / DC
- Withstanding voltage: 1000V AC/minute
- Temperature range: -25°C~+85°C
- Insulation resistance: ≥1000MΩ
- Contact resistance: ≤20mΩ
- After environmental testing: ≤30mΩ
- Mates With ADZL Wafer: 9127W



9127 H I -XX X-PT XX
① ②③ ④ ⑤ ⑥ ⑦

- ① Series No.
- ② Category: H-HSG
- ③ Appearance type: I-HSG+hardware
- ④ Row No.-Pin No.: XX-Single Row
- ⑤ Plug the Pin & Special No.:
- ⑥ Material : PT-PBT 94V-0
- ⑦ Color: RD-Purplish Red Color
RE-Red Color

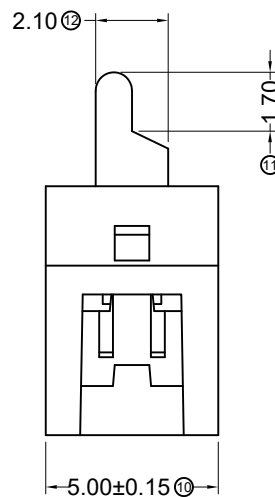
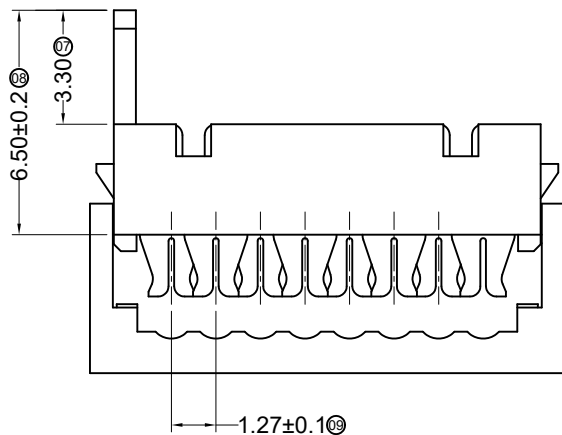
Poles	Dimensions (mm)		Poles	Dimensions (mm)	
	A	B		A	B
04	8.45	2.54	16	23.69	17.78
06	10.99	5.08	18	26.23	20.32
08	13.53	7.62	20	28.77	22.86
10	16.07	10.16	22	31.31	25.40
12	18.61	12.70	24	33.85	27.94
14	21.15	15.24	26	36.39	30.48



DATE	OLD REV	NEW REV	ECN	DESCRIPTION	CHECK	APPROVAL

GENERAL TOLERANCE	
.X	±0.30
.XX	±0.20
.XXX	±0.10
PROJECT	
	

 东莞市思量连接器有限公司
DONGGUAN ADZL CONNECTORS CO.,LTD.

APPROVAL	CHECK	DRAWN	DATA
Ken	Zhao Hong	Allen	2017/08/01

PART NO. 9127HI-XX-PTRX			
TITLE 1.27 mm Crimp Style Connector			
UNIT MM	SCALE 1 : 1	NUMBER	REV

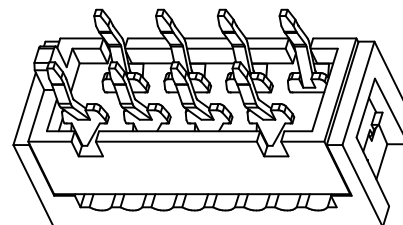
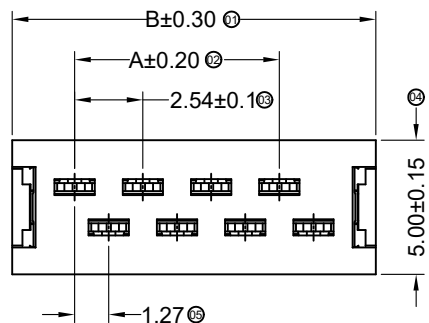

■ Specifications :

- Voltage rating: 500V AC / DC
- Current rating: 1A AC / DC
- Withstanding voltage: 1000V AC/minute
- Temperature range: -40°C~+105°C
- Insulation resistance: ≥1000MΩ
- Contact resistance: ≤20mΩ
- After environmental testing: ≤30mΩ

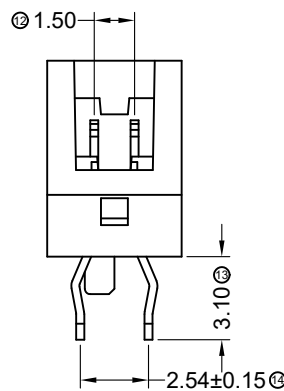
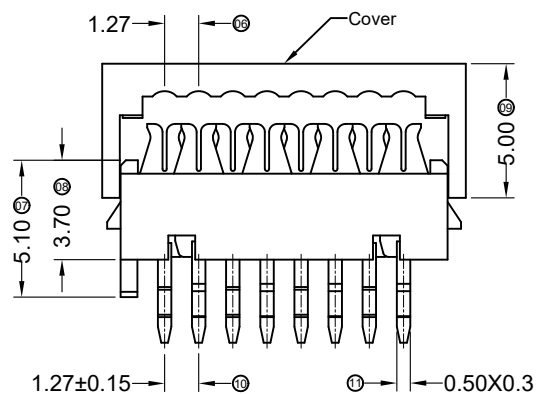

9127 H I - XX A - PT XX

① ② ③ ④ ⑤ ⑥ ⑦

- ① Series No.
- ② Category: H-HSG
- ③ Welding Board Angle: I-HSG+hardware
- ④ Row No.-Pin No.: XX-Single row
- ⑤ Plug the Pin & special No.: A-Double Deficiency
- ⑥ Material: PT-PBT 94V-0
- ⑦ Color: RE- Red; RD-purplish red

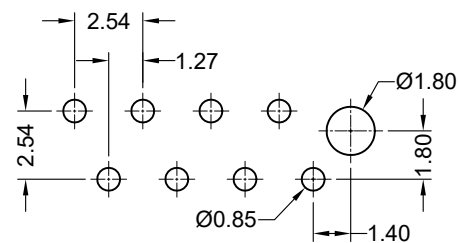

Recommended P.C.B Layout
General Tolerance±0.05

Poles	Dimensions(mm)		Poles	Dimensions(mm)	
	A	B		A	B
04	2.54	8.45	16	17.78	23.69
06	5.08	10.99	18	20.32	26.23
08	7.62	13.53	20	22.86	28.77
10	10.16	16.07	22	25.40	31.31
12	12.70	18.61	24	27.94	33.85
14	15.24	21.15	26	30.48	36.39

DATE	OLD REV	NEW REV	ECN	DESCRIPTION	CHECK	APPROVAL

GENERAL TOLERANCE
.X ±0.30
.XX ±0.20
.XXX ±0.10

 东莞市思量连接器有限公司
DONGGUAN ADZL CONNECTORS CO.,LTD.

APPROVAL: Ken
CHECK: Zhao Hong
DRAWN: Allen
DATA: 2014/02/22

PART NO. 9127HI-XXA-PTXX
TITLE 1.27 mm Crimp Style Connectors
UNIT: MM, SCALE: 1:1, NUMBER, REV

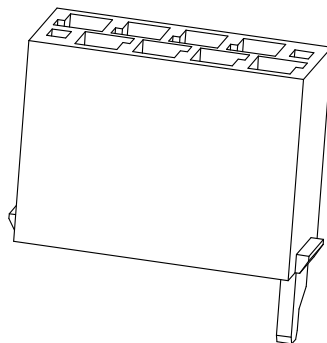
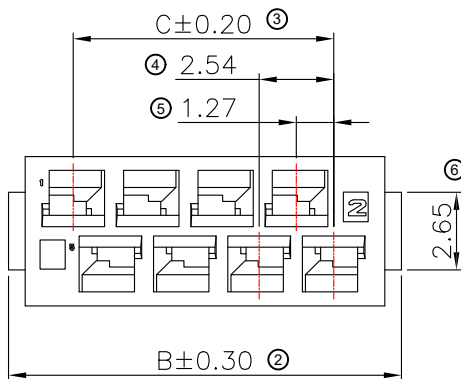

Specifications :

- Voltage rating: 500V AC / DC
- Current rating: 1.0A AC / DC
- Withstanding voltage: 500V AC/minute
- Temperature range: -25°C~+85°C
- Insulation resistance: ≥1000MΩ
- Contact resistance: ≤20mΩ
- After environmental testing: ≤30mΩ
- Mates With ADZL Terminal 9127TM

9127 H F -2*XX-XX XX
 ① ② ③ ④ ⑤ ⑥

- ① Series No.
- ② Category: H-HSG
- ③ Appearance type: M-Male HGS; F-Female HGS
- ④ Row No.-Pin No.: 2*XX-2*02P~2*13P
- ⑤ Material: PT-PBT; N0-PA66 94V-0; N2-PA66 94V-2
- ⑥ Color: RE-red ; PR-purple ;
Blank-natural color ; BK-black

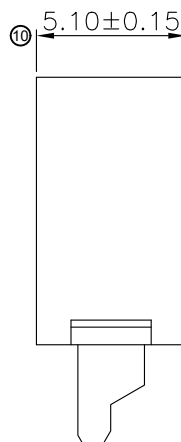
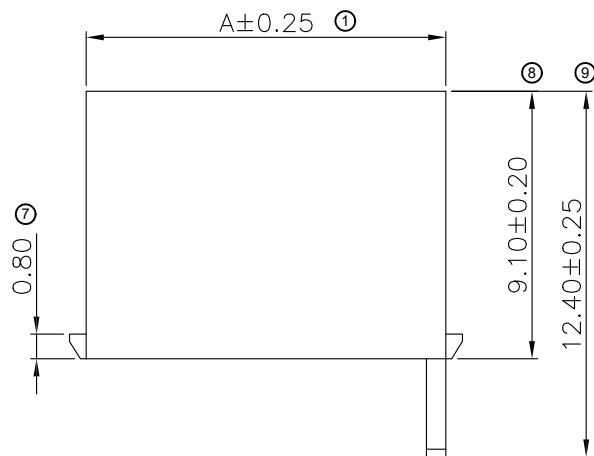

Poles	Dimensions (mm)			Poles	Dimensions (mm)		
	A	B	C		A	B	C
2*02	7.20	8.40	3.81	2*08	22.50	23.60	19.05
2*03	9.80	10.90	6.35	2*09	25.00	26.20	21.59
2*04	12.30	13.50	8.89	2*10	27.60	28.70	24.13
2*05	14.90	16.00	11.43	2*11	30.20	31.20	26.67
2*06	17.40	18.50	13.97	2*12	32.80	33.80	29.21
2*07	19.90	21.10	16.51	2*13	35.40	36.40	31.75

DATE	OLD REV	NEW REV	ECN	DESCRIPTION	CHECK	APPROVAL

GENERAL TOLERANCE	
.X	±0.30
.XX	±0.20
.XXX	±0.10

 东莞市思量连接器有限公司
 DONGGUAN ADZL CONNECTORS CO.,LTD.

APPROVAL	CHECK	DRAWN	DATA
Ken	Zhao Hong	Allen	2022/09/22

PART NO.			
9127HF-2*XX-XXXX			
TITLE			
1.27mm Crimp Style Connectors			
UNIT	SCALE	NUMBER	REV
mm	1:1		

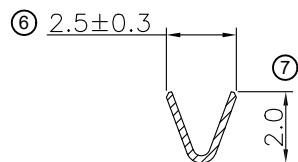
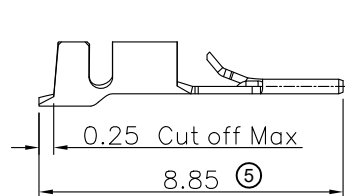
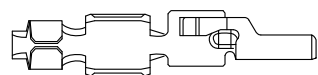
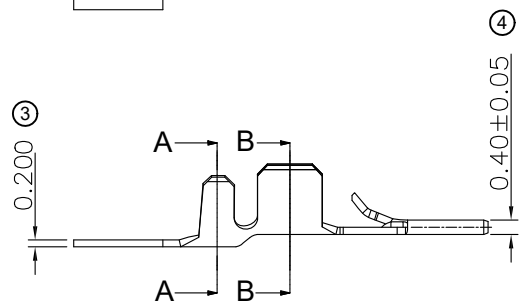
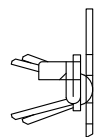
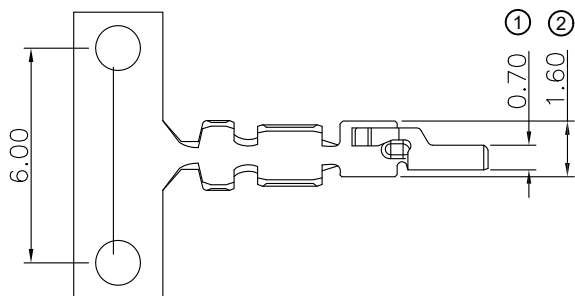

SEC.A-A

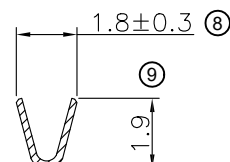

SEC.B-B

■ Specifications :

- Voltage rating: 500V AC / DC
- Current rating: 1.0A AC / DC
- Withstanding voltage: 500V AC/minute
- Temperature range: -25°C~+85°C
- Insulation resistance: ≥1000MΩ
- Contact resistance: ≤20mΩ
- After environmental testing: ≤30mΩ
- Mates With ADZL Housing: 9127HF-2*XX-XXXX
- Wire Range: 24~20AWG; Insulation O.D.1.85mm(Max)

9127 T M -X XX

① ②③ ④ ⑤

- ① Series Number
- ② Category: T-terminal
- ③ Shape: M-male ; F-Female;
- ④ Material: P-Phosphor bronze ; B-Brass ;
- ⑤ Plating style: SN-Bright tin plating
G01-Gold flash for Contact area
G15-15u" Au for Contact area
G30-30u" Au for Contact area

GENERAL TOLERANCE

.X ±0.30
.XX ±0.20
.XXX ±0.10

 东莞市思量连接器有限公司
DONGGUAN ADZL CONNECTORS CO.,LTD.

APPROVAL CHECK DRAWN DATA

Ken Zhao Hong Sunny 2018/05/08

PART NO. 9127TM-XXX

TITLE 1.27mm Crimp Style Connectors

UNIT mm SCALE 1:1 NUMBER REV

DATE	OLD REV	NEW REV	ECN	DESCRIPTION	CHECK	APPROVAL

