

02P~04P Single Hole
Scale 1:0.7

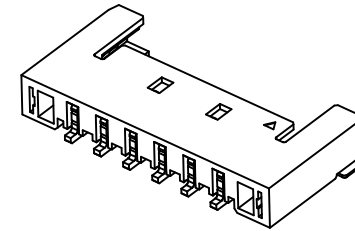
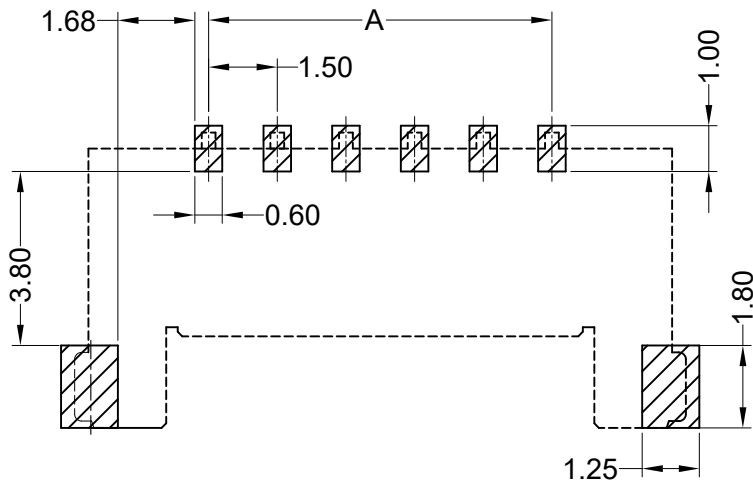
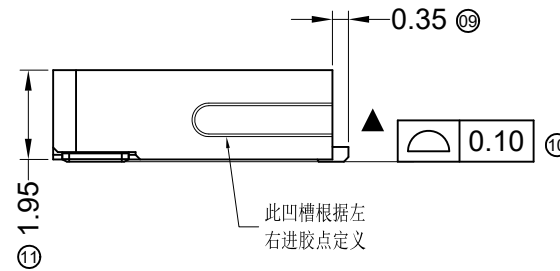
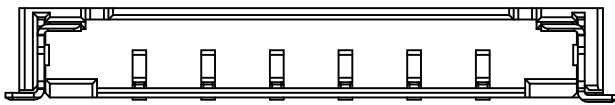

■ Specifications :

- Voltage rating: 150V AC / DC
- Current rating: 3A AC / DC
- Withstanding voltage: 500V AC/minute
- Temperature range: -25°C~+85°C
- Insulation resistance: ≥1000MΩ
- Contact resistance: ≤20mΩ
- After environmental testing: ≤40mΩ

1503 W R S-XX XX-4T V01 BK -01

① ② ③ ④ ⑤ ⑥ ⑦ ⑧ ⑨ ⑩

- ① Series No.
- ② Category: W-wafer
- ③ Welding Board Angle: R- Right Angle 90°
- ④ Welding Way: S-SMT
- ⑤ Row No.-Pin No.: XX-02P~12P
- ⑥ Plug the Pin & Special No.
- ⑦ Material: 4T-PA4T 94V-0 ;
- ⑧ Plating Category: V01-Gold Flash
- ⑨ Color: Bk-Black
- ⑩ Number:01-New Mould

Poles	Dimensions(mm)		
	A	B	D
02	1.50	6.75	
03	3.00	8.25	
04	4.50	9.75	
05	6.00	11.25	3.00
06	7.50	12.75	3.00
07	9.00	14.25	4.50
08	10.50	15.75	6.00
09	12.00	17.25	7.50
10	13.50	18.75	9.00
11	15.00	20.25	10.50
12	16.50	21.75	12.00

1503WRS-XX-4TV01BK-01	PA4T UL 94V-0	Brass	Gold-Flash	Brass	Plating Tin	1503H-01
PART NO	Material	Material(Pin)	Finish(Pin)	Material (Solder Tabs)	Finish (Solder Tabs)	Mates With ADZL Housing

DATE	OLD REV	NEW REV	ECN	DESCRIPTION	CHECK	APPROVAL

GENERAL TOLERANCE	
.X	±0.30
.XX	±0.20
.XXX	±0.10
PROJECT	

ADZL 东莞市思量连接器有限公司
DONGGUAN ADZL CONNECTORS CO.,LTD.

APPROVAL	CHECK	DRAWN	DATA
Ken	Zhao Hong	Allen	2021/08/29

PART NO.			
1503WRS-XX-4TV01BK-01			
TITLE			
1.50 mm Crimp Style Connectors			
UNIT	SCALE	NUMBER	REV
MM	1 : 1		

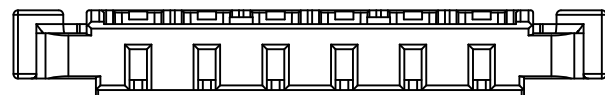
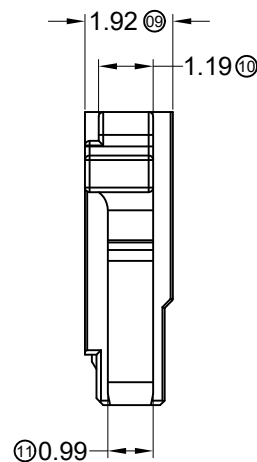
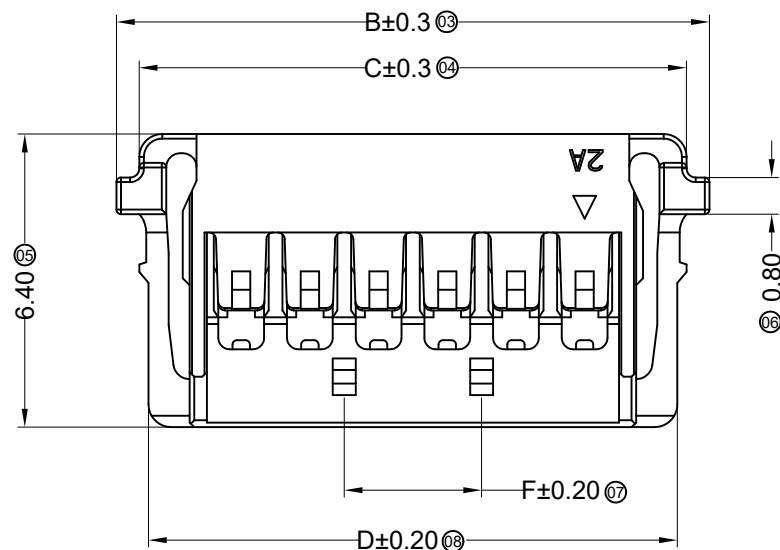
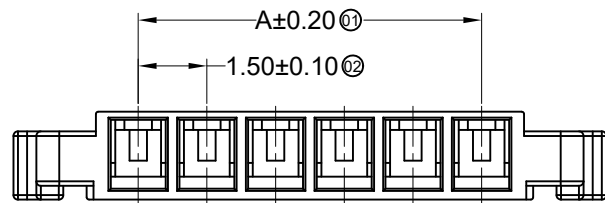

Specifications :

- Voltage rating: 150V AC / DC
- Current rating: 3A AC / DC
- Withstanding voltage: 500V AC/minute
- Temperature range: -25°C~+85°C
- Insulation resistance: ≥1000MΩ
- Contact resistance: ≤20mΩ
- After environmental testing: ≤40mΩ

1503 H -XX X -N0 XX -01

① ② ③ ④ ⑤ ⑥ ⑦

- ① Series No.
- ② Category: H-HSG
- ③ Row No.-Pin No.: XX-04~12P
- ④ Plug the Pin & special No.
- ⑤ Material: N0-PA66 94V-0
- ⑥ Color: Blank-Black color; WH-White
- ⑦ number:01-新模

Poles	Dimensions(mm)				
	A	B	C	D	F
02		6.95	5.95	5.55	
03	3.00	8.45	7.45	7.05	
04	4.50	9.95	8.95	8.55	
05	6.00	11.45	10.45	10.05	3.00
06	7.50	12.95	11.95	11.55	3.00
07	9.00	14.45	13.45	13.05	4.50
08	10.50	15.95	14.95	14.55	6.00
09	12.00	17.45	16.45	16.05	7.50
10	13.50	18.95	17.95	17.55	9.00
11	15.00	20.45	19.45	19.05	10.50
12	16.50	21.95	20.95	20.55	12.00

1503H-XX-N0-01	PA66 UL 94V-0	1503T	1503W
PART NO	Material	Suitable ADZL Terminal	Mates With ADZL Wafer

DATE	OLD REV	NEW REV	ECN	DESCRIPTION	CHECK	APPROVAL

GENERAL TOLERANCE
 .X ±0.30
 .XX ±0.20
 .XXX ±0.10



 东莞市思量连接器有限公司
 DONGGUAN ADZL CONNECTORS CO.,LTD.

APPROVAL CHECK DRAWN DATA

Ken Zhao Hong Allen 2020/09/29

PART NO. 1503H-XX-N0XX-01			
TITLE 1.50 mm Crimp Style Connectors			
UNIT MM	SCALE 1:1	NUMBER	REV

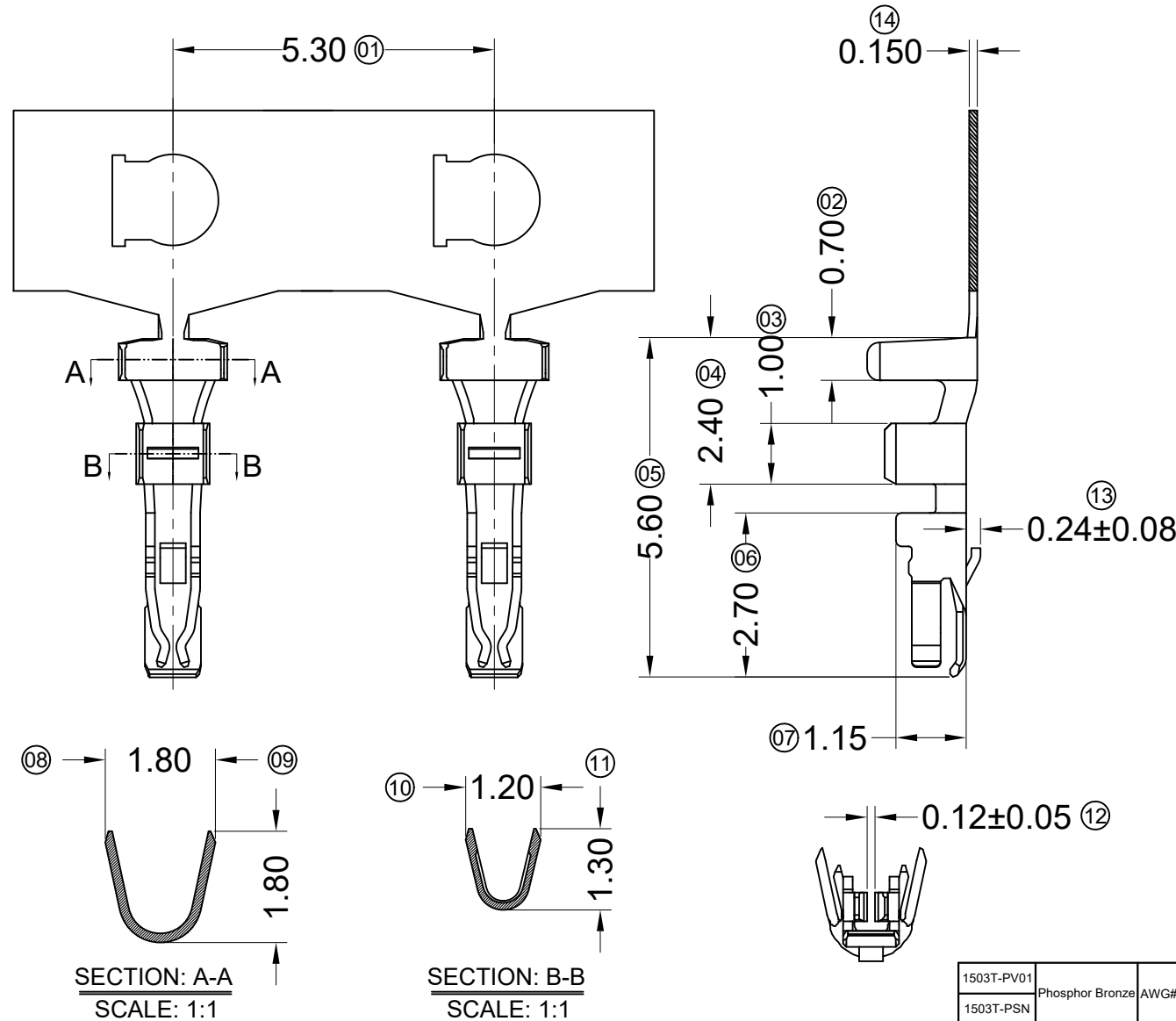

■ Specifications :

- Voltage rating: 150V AC / DC
- Current rating: 3A AC / DC
- Withstanding voltage: 500V AC/minute
- Temperature range: -25°C~+85°C
- Insulation resistance: ≥1000MΩ
- Contact resistance: ≤20mΩ
- After environmental testing: ≤40mΩ

1503 T X-P XXX X-X
 ① ②③④ ⑤ ⑥⑦

- ① Series Number
- ② Category: T-terminal
- ③ Shape: Blank-ordinary
- ④ Material: P-Phosphor bronze
- ⑤ Plating style:
 V01-Gold Flash
 SN-Bright tin plating ;
- ⑥ Plating method: Blank-Stamping before plating
- ⑦ Mold No./Mark/Special No.

SECTION: A-A
 SCALE: 1:1

SECTION: B-B
 SCALE: 1:1

1503T-PV01	Phosphor Bronze	AWG#24-28	1.10mm(Max)	Stamping Before Plating:30u" Ni MIN; Gold Flash	1503H
1503T-PSN				Stamping Before Plating:30u" Ni MIN; 70u"Sn Min.	
PART NO	Material	Wire Range	Insulation O.D.	Finish	Used In ADZL Housing

DATE	OLD REV	NEW REV	ECN	DESCRIPTION	CHECK	APPROVAL

GENERAL TOLERANCE
 .X ±0.30
 .XX ±0.20
 .XXX ±0.10



 东莞市思量连接器有限公司
 DONGGUAN ADZL CONNECTORS CO.,LTD.

APPROVAL	CHECK	DRAWN	DATA
Ken	Zhao Hong	Allen	2020/09/26

PART NO. 1503T-PXXX			
TITLE 1.50mm Crimp Style Connectors			
UNIT MM	SCALE 1:1	NUMBER	REV