

■ Specifications :

- Voltage rating: 250V AC / DC
- Current rating: 3A AC / DC
- Withstanding voltage: 800V AC/minute
- Temperature range: -40°C~+105°C
- Insulation resistance: ≥1000MΩ
- Contact resistance: ≤20mΩ
- After environmental testing: ≤40mΩ
- Material(Pin): Phorphos Bronze
- Material(Stator): Brass
- Applicable ADZL Housing: 2023H

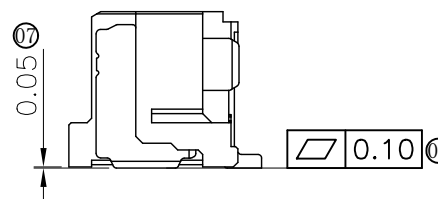
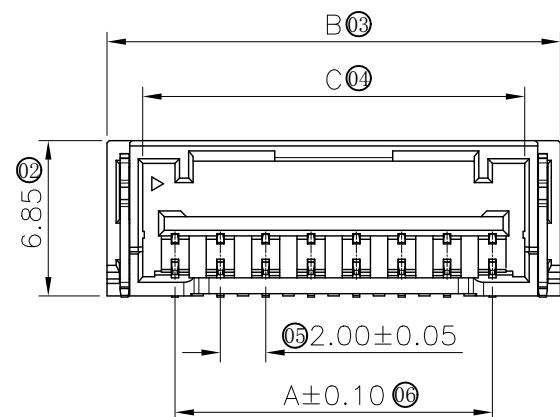

2023 W R S - XX HF - 9T SW N R

① ② ③ ④ ⑤ ⑥ ⑦ ⑧ ⑨ ⑩

- ① Series No: 2023
- ② Category: W - Wafer
- ③ Connector Type: R - Right Angle 90°
- ④ Mouting Type: S - SMT
- ⑤ Row No.-Pin No: XX - Single Row XXPin
- ⑥ RoHS: HF - Halogen Free
- ⑦ Plastic material: 9T - PA9T UL94V-0
- ⑧ Plating Code: SW - Matte Tin
- ⑨ Color: N - Natural
- ⑩ Packing: R - Reel

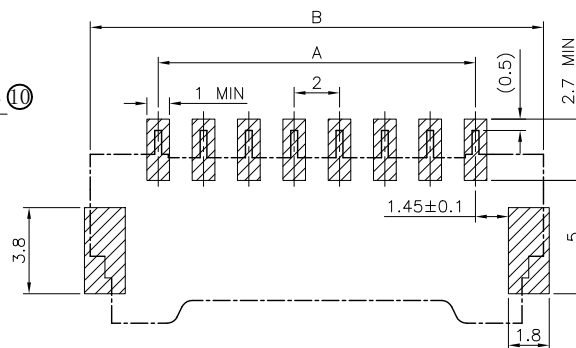
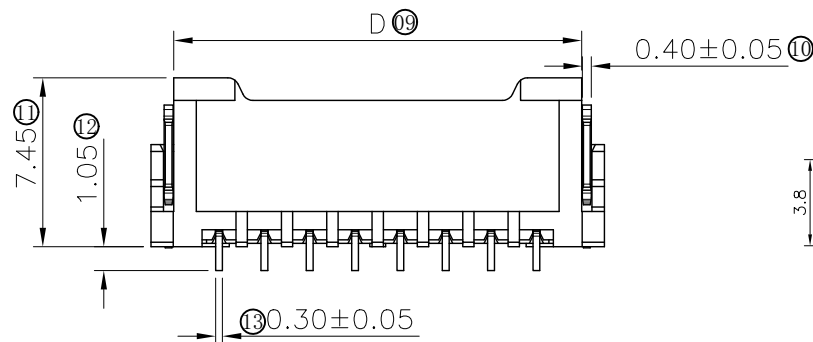

Recommended P.C.B LAYOUT
General Tolerance±0.05

Poles	Dimensions (mm)				Poles	Dimensions (mm)			
	A	B	C	D		A	B	C	D
02	2.00	8.00	4.85	6.00	09	16.00	22.00	18.85	20.00
03	4.00	10.00	6.85	8.00	10	18.00	24.00	20.85	22.00
04	6.00	12.00	8.85	10.00	11	20.00	26.00	22.85	24.00
05	8.00	14.00	10.85	12.00	12	22.00	28.00	24.85	26.00
06	10.00	16.00	12.85	14.00	13	24.00	30.00	26.85	28.00
07	12.00	18.00	14.85	16.00	14	26.00	32.00	28.85	30.00
08	14.00	20.00	16.85	18.00	15	28.00	34.00	30.85	32.00

DATE	REV	ECN ON.	DESCRIPTION	MODIFY	APPROVAL
1					
2					
3					
4					

GENERAL TOLERANCE
.X ±0.30
.XX ±0.20
.XXX ±0.10
X.° ±1°

PROJECT

APPROVAL: Ken
CHECK: Zhao Hong
DRAWN: Allen
DATE: 2020/09/15

PART NO: 2023WRS-XXHF-9TSWNR

TITLE: 2.00mm Crimp Style Connectors

UNIT	SCALE	SHEET	REV	NUMBER
mm	3:1	1/1		

ADZL 东莞市思量连接器有限公司
DONGGUAN ADZL CONNECTORS CO.,LTD.

RoHS

品保部检验图-内部专用

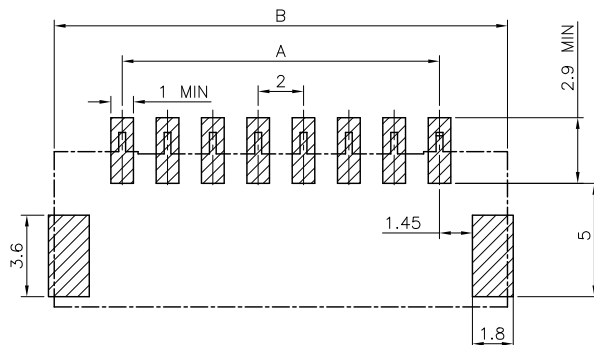
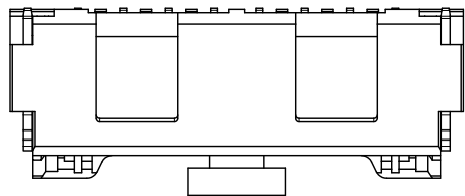

Recommended P.C.B LAYOUT
General Tolerance±0.05

Specifications :

- Voltage rating: 250V AC / DC
- Current rating: 3A AC / DC
- Withstanding voltage: 800V AC/minute
- Temperature range: -40°C~+105°C
- Insulation resistance: ≥1000MΩ
- Contact resistance: ≤20mΩ
- After environmental testing: ≤40mΩ
- Material(Pin): Phorphos Bronze
- Material(Stator): Brass
- Applicable ADZL Housing: 2023H

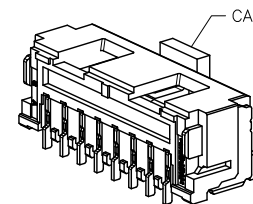
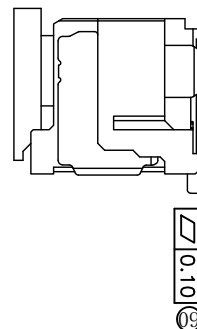
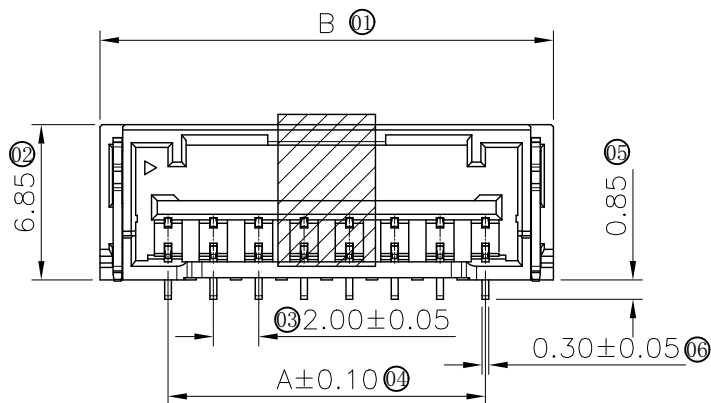

2023 W V S - XX HF - 9T SW N R

① ② ③ ④ ⑤ ⑥ ⑦ ⑧ ⑨ ⑩

- ① Series No: 2023
- ② Category: W - Wafer
- ③ Connector Type: V - Straight 180°
- ④ Mouting Type: S - SMT
- ⑤ Row No.-Pin No: XX - Single Row XXPin
- ⑥ RoHS: HF - Halogen Free
- ⑦ Plastic material: 9T - PA9T UL94V-0
- ⑧ Plating Code: SW - Matte Tin
- ⑨ Color: N - Natural
- ⑩ Packing: R - Reel

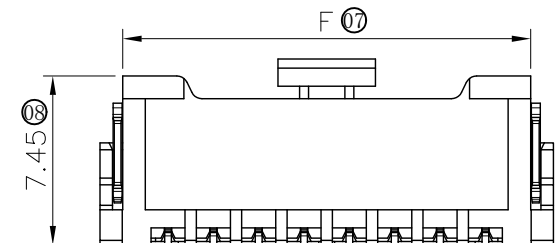

Poles	Dimensions (mm)			Poles	Dimensions (mm)		
	A	B	F		A	B	F
02	2.00	8.00	6.00	09	16.00	22.00	20.00
03	4.00	10.00	8.00	10	18.00	24.00	22.00
04	6.00	12.00	10.00	11	20.00	26.00	24.00
05	8.00	14.00	12.00	12	22.00	28.00	26.00
06	10.00	16.00	14.00	13	24.00	30.00	28.00
07	12.00	18.00	16.00	14	26.00	32.00	30.00
08	14.00	20.00	18.00	15	28.00	34.00	32.00

DATE	REV	ECN ON.	DESCRIPTION	MODIFY	APPROVAL
1					

GENERAL TOLERANCE
.X ±0.30
.XX ±0.20
.XXX ±0.10
X.° ±1°
PROJECT

ADZL 东莞市思量连接器有限公司
DONGGUAN ADZL CONNECTORS CO.,LTD.

APPROVAL: Ken
CHECK: Zhao Hong
DRAWN: Allen
DATE: 2020/09/15

PART NO: 2023WVS-XXHF-9TSWNR

TITLE: 2.00mm Crimp Style Connectors

UNIT	SCALE	SHEET	REV	NUMBER
mm	3:1	1/1	A	

RoHS

WWW.ADZLCONN.COM

TEL:0769-82285488

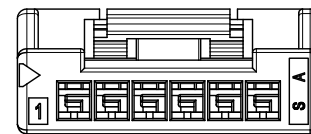
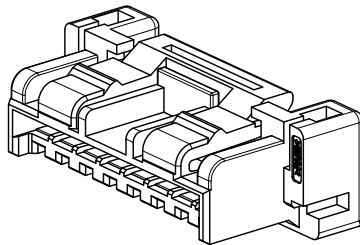
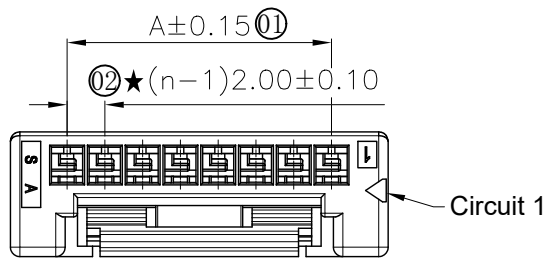

5P-7P外观形状

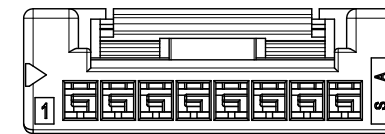

8P-10P外观形状

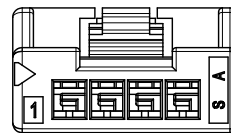

2P-4P外观形状

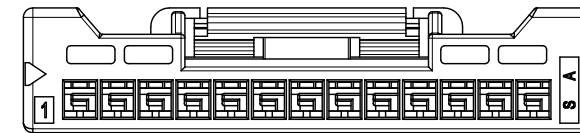

11P-15P外观形状

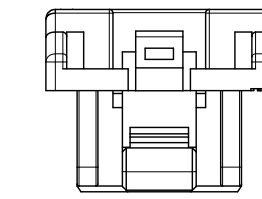
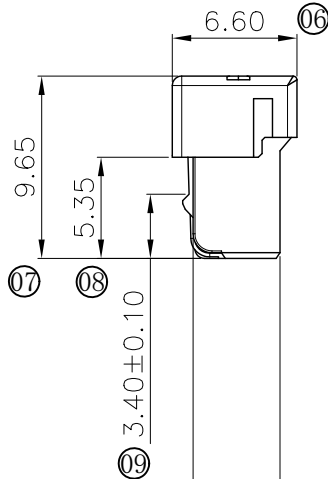
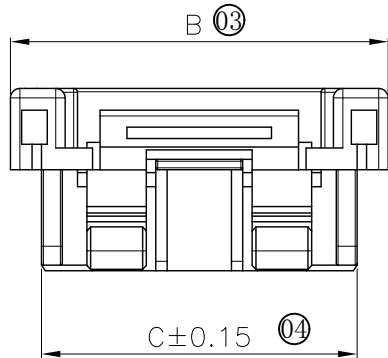

2P-4P锁扣形状

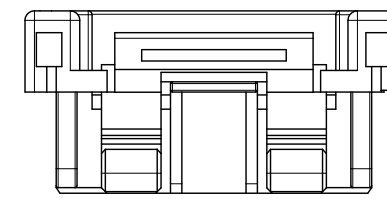

5P-15P锁扣形状

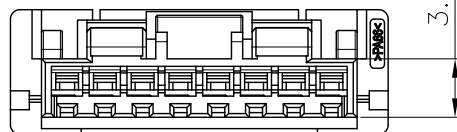

(10) 4.85(02Pin)
4.60(03Pin~15Pin)

2023 H - XX - N0 HF WH

(1) (2) (3) (4) (5) (6)

- (1) Series No.: 2023
- (2) Category: H - Housing
- (3) Row No.-Pin No: XX - Single Row XXPin
- (4) Plastic material: N0 - PA66 UL94V-0
- (5) RoHS: HF - Halogen Free
- (6) Color: WH - White

Poles	Dimensions (mm)			Poles	Dimensions (mm)		
	A	B	C		A	B	C
02	2.00	8.00	4.70	09	16.00	22.00	18.70
03	4.00	10.00	6.70	10	18.00	24.00	20.70
04	6.00	12.00	8.70	11	20.00	26.00	22.70
05	8.00	14.00	10.70	12	22.00	28.00	24.70
06	10.00	16.00	12.70	13	24.00	30.00	26.70
07	12.00	18.00	14.70	14	26.00	32.00	28.70
08	14.00	20.00	16.70	15	28.00	34.00	30.70

Specifications :

- Voltage rating: 250V AC / DC
- Current rating: 3A AC / DC
- Withstanding voltage: 800V AC/minute
- Temperature range: -40°C~+105°C
- Insulation resistance: ≥1000MΩ
- Contact resistance: ≤20mΩ
- After environmental testing: ≤40mΩ
- Applicable ADZL Terminal: 2023T
- Applicable ADZL Wafer: 2023WRS&2023WVS
- "★"represents special characterical dimension

GENERAL TOLERANCE

- .X ±0.30
- .XX ±0.20
- .XXX ±0.10
- X.° ±1°

PROJECT



ADZL 东莞市思量连接器有限公司
DONGGUAN ADZL CONNECTORS CO.,LTD.

PART NO.
2023H-XX-N0HFWH

TITLE
2.00mm Crimp Style Connectors

APPROVAL CHECK DRAWN DATE

Ken Zhao Hong Allen 2020/09/15

UNIT	SCALE	SHEET	REV	NUMBER
mm	2.5:1	1/1		

DATE	REV	ECN ON.	DESCRIPTION	MODIFY	APPROVAL
------	-----	---------	-------------	--------	----------

1 2 3 4 5 6 7 8

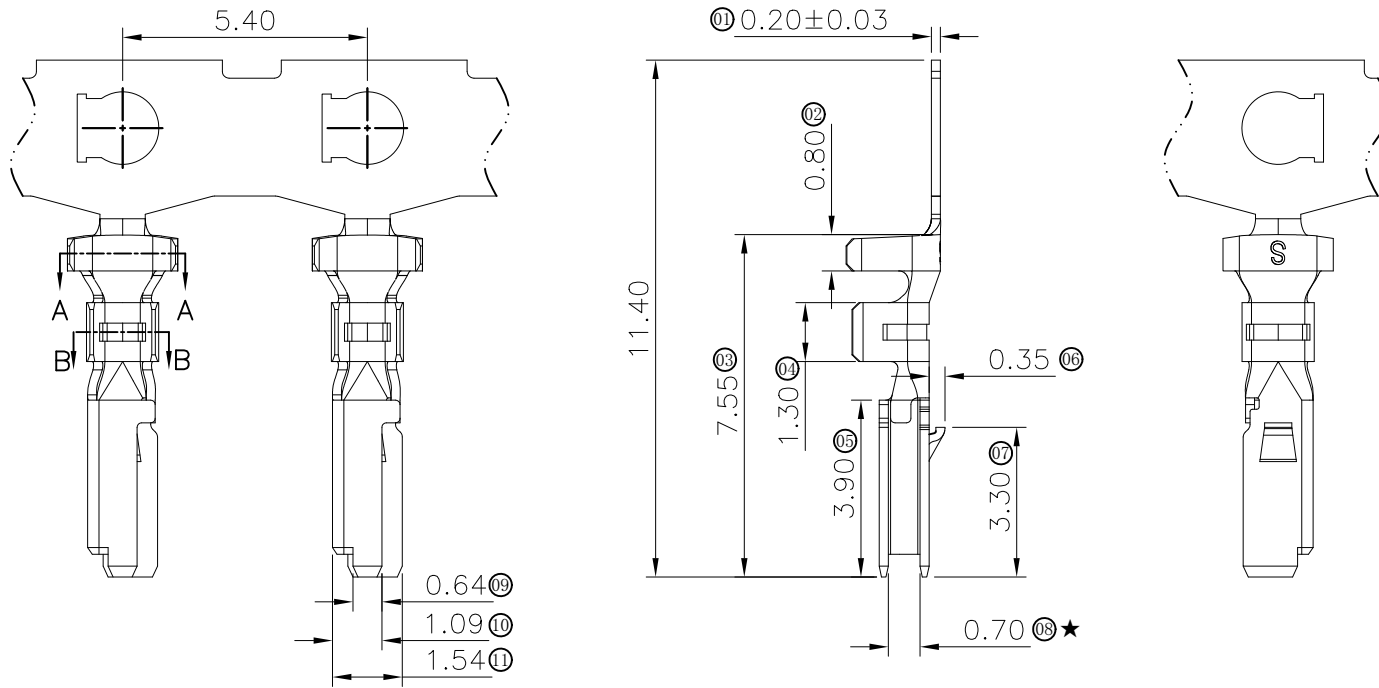

- Specifications :
- Voltage rating: 250V AC / DC
 - Current rating: 3A AC / DC
 - Withstanding voltage: 800V AC/minute
 - Temperature range: -40°C~+105°C
 - Insulation resistance: ≥1000MΩ
 - Contact resistance: ≤20mΩ
 - After environmental testing: ≤40mΩ
 - "★"represents special characterical dimension

2023 T X - P SN1

① ② ③ ④ ⑤

- ① Series No.: 2023
- ② Category: T-Terminal
- ③ Shape: Blank-Ordinary Barrel
L-Low Barrel
- ④ Material: P-Phosphor bronze
- ⑤ Plating Code: SN1-See table

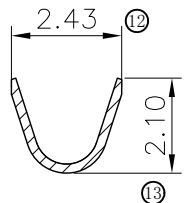

SECTION: A-A
SCALE 1:1

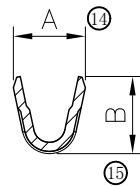

SECTION: B-B
SCALE 1:1

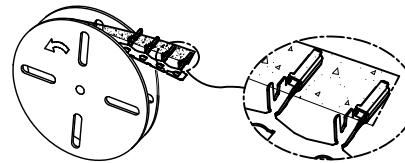

After Plating

SCALE 4:1

2023TL-PSN1	Phosphor bronze	AWG#24~26 (0.22~0.13mm ²)	Ø1.05~1.2mm	Ni:40~120u"(1.0~3.0um) Bright tin:80~200u"(2.0~5.0um)	2023H	1.45	1.35
2023T-PSN1		AWG#22~24 (0.35~0.22mm ²)	Ø1.2~1.4mm			1.60	1.70
P/N	Material	Wire Range	Insulation O.D.	Finish	Applicable ADZL HSG	A	B

					GENERAL TOLERANCE .X ±0.30 .XX ±0.20 .XXX ±0.10 X.° ±1° PROJECT				东莞市思量连接器有限公司 DONGGUAN ADZL CONNECTORS CO.,LTD.				PART NO. 2023TX-PSN1											
					APPROVAL Ken				CHECK Zhao Hong				DRAWN Allen				DATE 2020/09/15				TITLE 2.00mm Crimp Terminal			
DATE	REV	ECN ON.	DESCRIPTION	MODIFY	APPROVAL					UNIT	SCALE	SHEET	REV	NUMBER										
										mm	6:1	1/1												