

RoHS

WWW.ADZLCONN.COM

TEL:0769-82285488

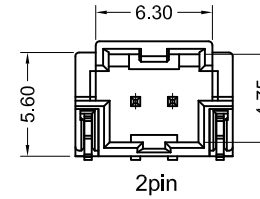
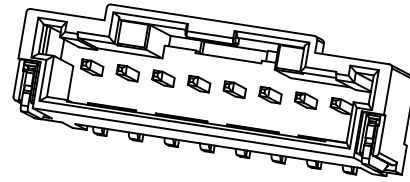
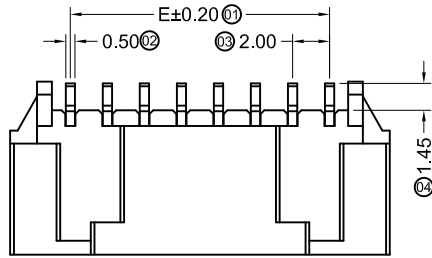

2pin

- Specifications :
- Voltage rating: 125V AC / DC
 - Current rating: 3A AC / DC
 - Withstanding voltage: 500V AC/minute
 - Temperature range: -40°C~+105°C
 - Insulation resistance: ≥1000MΩ
 - Contact resistance: ≤10mΩ
 - After environmental testing: ≤20mΩ
 - Material(Pin): Brass
 - Mates With ADZL Housing: 2008H

2008 W R S - 1 x XX - XX X B 05 R R XXX Q
 ① ② ③ ④ ⑤ ⑥ ⑦ ⑧ ⑨ ⑩ ⑪ ⑫ ⑬

- ① Series No.
- ② Category: W-wafer
- ③ Welding Board Angle: R-Right Angle 90°
- ④ Welding form: S-SMT
- ⑤ Row No.-Pin No: 1xXX-Single Row 1xXXPin
- ⑥ Plastic material: 9T- PA9T 94V-0; LP- LCP 94V-0
- ⑦ Color: N-Natural; B-Black; R-Red; L-Blue
- ⑧ Metal material: B-Brass
- ⑨ Plating Category: 05-Matte Tin
- ⑩ Packag: R-Reel
- ⑪ Green code: H-Halogen-Free R-Rohs
- ⑫ Water code: 002-Coldsealing ;02C-Heatsealing
- ⑬ Special code:Q-Automotive Connectors

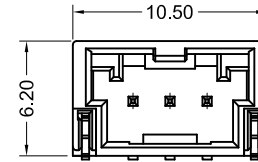
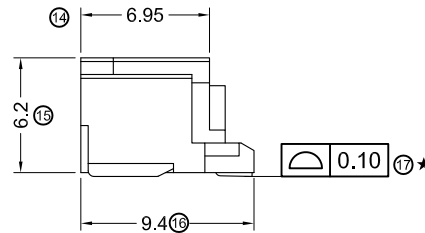
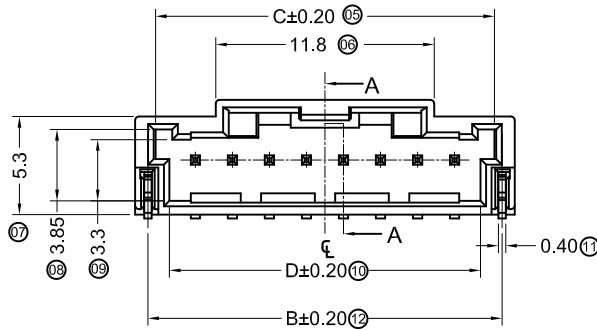

3pin

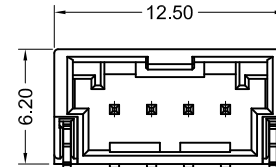

4pin

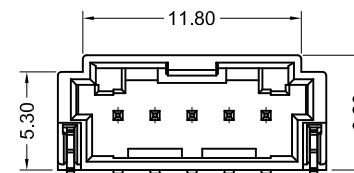

5pin

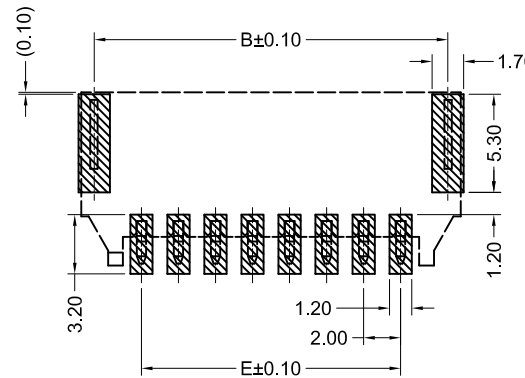
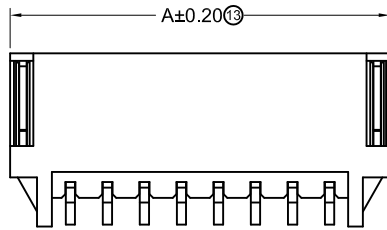

RECOMMENDED P.C.B LAYOUT
(TOLERANCE:±0.05)

Poles	Dimensions (mm)				
	A	B	C	D	E
02	8.50	7.13	6.30	4.80	2.00
03	10.50	9.13	8.30	6.80	4.00
04	12.50	11.13	10.30	8.80	6.00
05	14.50	13.13	12.30	10.80	8.00
06	16.50	15.13	14.30	12.80	10.00
07	18.50	17.13	16.30	14.80	12.00
08	20.50	19.13	18.30	16.80	14.00
09	22.50	21.13	20.30	18.80	16.00
10	24.50	23.13	22.30	20.80	18.00
11	26.50	25.13	24.30	22.80	20.00
12	28.50	27.13	26.30	24.80	22.00
13	30.50	29.13	28.30	26.80	24.00
14	32.50	31.13	30.30	28.80	26.00
15	34.50	33.13	32.30	30.80	28.00

GENERAL TOLERANCE
 .X ±0.30
 .XX ±0.20
 .XXX ±0.10

ADZL 东莞市思量连接器有限公司
 DONGGUAN ADZL CONNECTORS CO.,LTD.

PART NO.
 2008WRS-1xXX-XXXB05RRXXXQ

TITLE
 Pitch 2.00 mm 90° SMT Wafer Connectors

APPROVAL: Ken, CHECK: Zhao Hong, DRAWN: Allen, DATA: 2018.10.16

UNIT: mm, SCALE: 1:1, NUMBER, REV

DATE	OLD REV	NEW REV	ECN	DESCRIPTION	CHECK	APPROVAL
1						
2						
3						
4						

PROJECT

RoHS

WWW.ADZLCONN.COM

TEL:0769-82285488

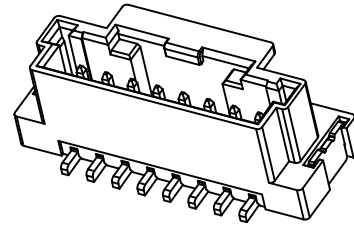
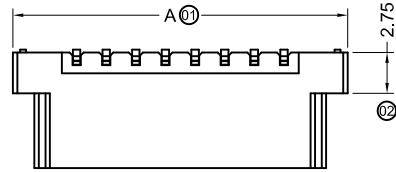

Specifications :

- Voltage rating: 125V AC / DC
- Current rating: 3A AC / DC
- Withstanding voltage: 500V AC/minute
- Temperature range: -40°C~+105°C
- Insulation resistance: ≥1000MΩ
- Contact resistance: ≤10mΩ
- After environmental testing: ≤20mΩ
- Material(Pin): Barss
- Mates With ADZL Housing: 2008H

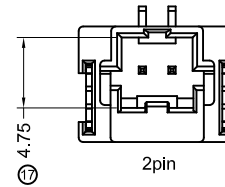
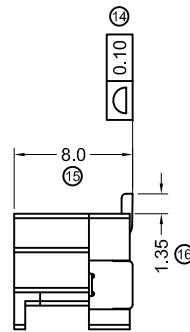
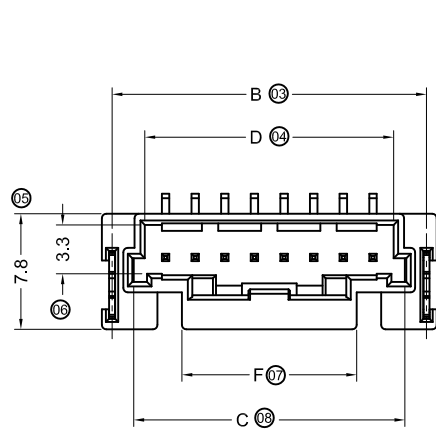

2pin

2008 W V S - 1 x XX - XX X B XX X R XXX Q
 ① ② ③ ④ ⑤ ⑥ ⑦ ⑧ ⑨ ⑩ ⑪ ⑫ ⑬

- ① Series No.
- ② Category: W-wafer
- ③ Welding Board Angle: V-Straight 180°
- ④ Welding form: S-SMT
- ⑤ Row No.-Pin No: 1xXX-Single Row 1xXXPin
- ⑥ Plastic material: 9T- PA9T 94V-0; LP- LCP 94V-0
- ⑦ Color: N-Natural; B-Black; R-Red; L-Blue
- ⑧ Metal material: B-Brass
- ⑨ Plating Category: 05-Matte Tin
- ⑩ Packag: R-Reel ,Without Mylar
- ⑪ Green code: R-RoHS H-Halogen-Free
- ⑫ Water code: 002-Coldsealing ;02C-Heatsealing
- ⑬ Special code :Q-Automotive Connectors

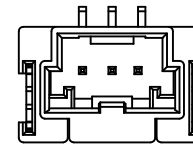

3pin

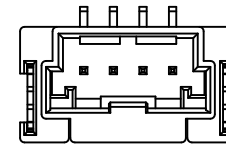

4pin

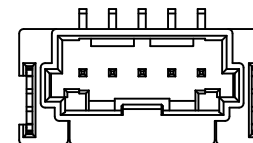

5pin

Poles	Dimensions (mm)					
	A	B	C	D	E	F
02	10.60	9.23	6.30	4.80	2.00	6.30
03	12.60	11.23	8.30	6.80	4.00	5.80
04	14.60	13.23	10.30	8.80	6.00	7.80
05	16.60	15.23	12.30	10.80	8.00	9.80
06	18.60	17.23	14.30	12.80	10.00	11.80
07	20.60	19.23	16.30	14.80	12.00	11.80
08	22.60	21.23	18.30	16.80	14.00	11.80
09	24.60	23.23	20.30	18.80	16.00	11.80
10	26.60	25.23	22.30	20.80	18.00	11.80
11	28.60	27.23	24.30	22.80	20.00	11.80
12	30.60	29.23	26.30	24.80	22.00	11.80
13	32.60	31.23	28.30	26.80	24.00	11.80
14	34.60	33.23	30.30	28.80	26.00	11.80
15	36.60	35.23	32.30	30.80	28.00	11.80

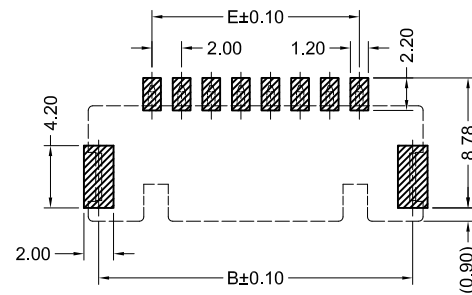

RECOMMENDED P.C.B LAYOUT
(TOLERANCE:±0.05)

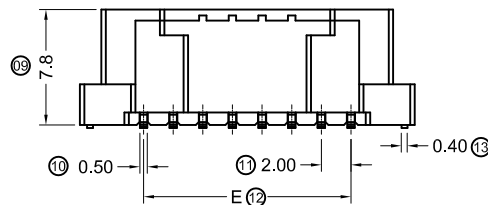

GENERAL TOLERANCE
 .X ±0.30
 .XX ±0.20
 .XXX ±0.10

ADZL 东莞市思量连接器有限公司
 DONGGUAN ADZL CONNECTORS CO.,LTD.

PART NO.
 2008WVS-1xXX-XXXBXXRRXXXQ

TITLE
 Pitch 2.00 mm 180° SMT Wafer Connectors

PROJECT

APPROVAL	CHECK	DRAWN	DATA
Ken	Zhao Hong	Allen	2020/06/15

UNIT	SCALE	NUMBER	REV
MM	1:1		

DATE	OLD REV	NEW REV	ECN	DESCRIPTION	CHECK	APPROVAL
1						

RoHS

Part NO.

Dimensions/mm

WWW.ADZLCONN.COM

TEL:0769-82285488

Part NO.	Dimensions/mm			
	A	B	C	D
02	2.00	4.70	6.10	8.00
03	4.00	6.70	8.10	10.00
04	6.00	8.70	10.10	12.00
05	8.00	10.70	12.10	14.00
06	10.00	12.70	14.10	16.00
07	12.00	14.70	16.10	18.00
08	14.00	16.70	18.10	20.00
09	16.00	18.70	20.10	22.00
10	18.00	20.70	22.10	24.00
11	20.00	22.70	24.10	26.00
12	22.00	24.70	26.10	28.00
13	24.00	26.70	28.10	30.00
14	26.00	28.70	30.10	32.00
15	28.00	30.70	32.10	34.00

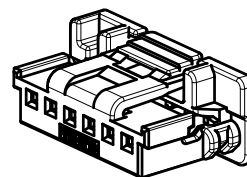

Specifications :

- Voltage rating: 125V Max. AC/DC
- Withstanding voltage: 1000V AC/minute
- Temperature range: -40°C~+125°C
- Insulation resistance: 100MΩ min./500V DC/Minute
- Mates With ADZL Terminal: A2022T-XXX-A
- Mates With ADZL TPA: AC2022-XXA
- Mates With ADZL Wafer: 2008WX-XX
- Symbols for SPC dimensions:" ★ "
- Product Specification: PS-A2022-03
- Packaging Drawing: PK-A2022H-XXA-PTNC

A2022 H - XX A - PT NC

① ② ③ ④ ⑤ ⑥

- ① Series No.: A2022
- ② Connector Type: H-Housing
- ③ Row No.-Pin No: XX-Single Row 02~15Pin
- ④ Special No.: A-A Type
- ⑤ Plastic material: PT-PBT UL94V-0
- ⑥ Color: NC-Natural

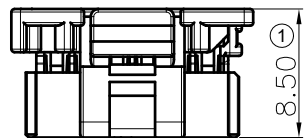

A VIEW

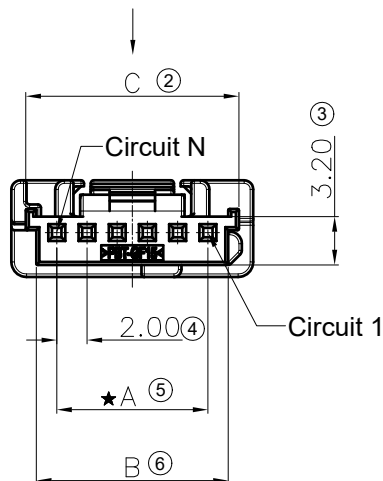

B VIEW

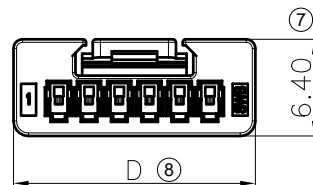
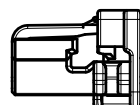

A VIEW

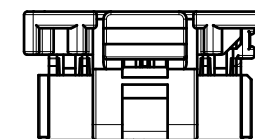
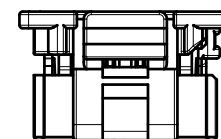
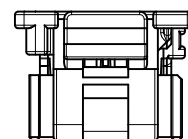
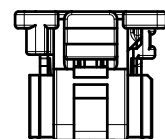
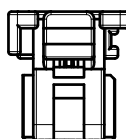

B VIEW

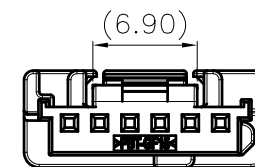
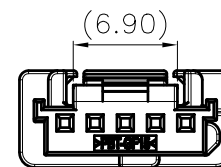
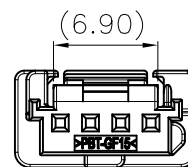
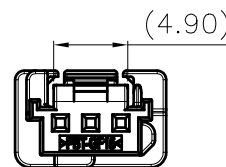
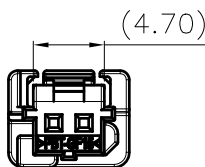

2P

3P

4P

5P

6~15P

GENERAL TOLERANCE

.X ±0.35

.XX ±0.25

.XXX ±0.15

X.° ±2°

PROJECT



东莞市思量连接器有限公司
DONGGUAN ADZL CONNECTORS CO.,LTD.

APPROVAL

CHECK

DRAWN

DATE

Ken

Zhao Hong

Allen

2022/05/25

PART NO.

A2022H-XXA-PTNC

TITLE 2.00 WTB CONN.

Housing

UNIT	SCALE	SHEET	REV	NUMBER
mm	2:1	1/1	A0	A-000

DATE

1

REV

2

ECN NO.

3

DESCRIPTION

MODIFY

4

APPROVAL

5

APPROVAL

6

CHECK

DRAWN

DATE

7

UNIT

SCALE

SHEET

REV

NUMBER

8

RoHS

WWW.ADZLCONN.COM

TEL:0769-82285488

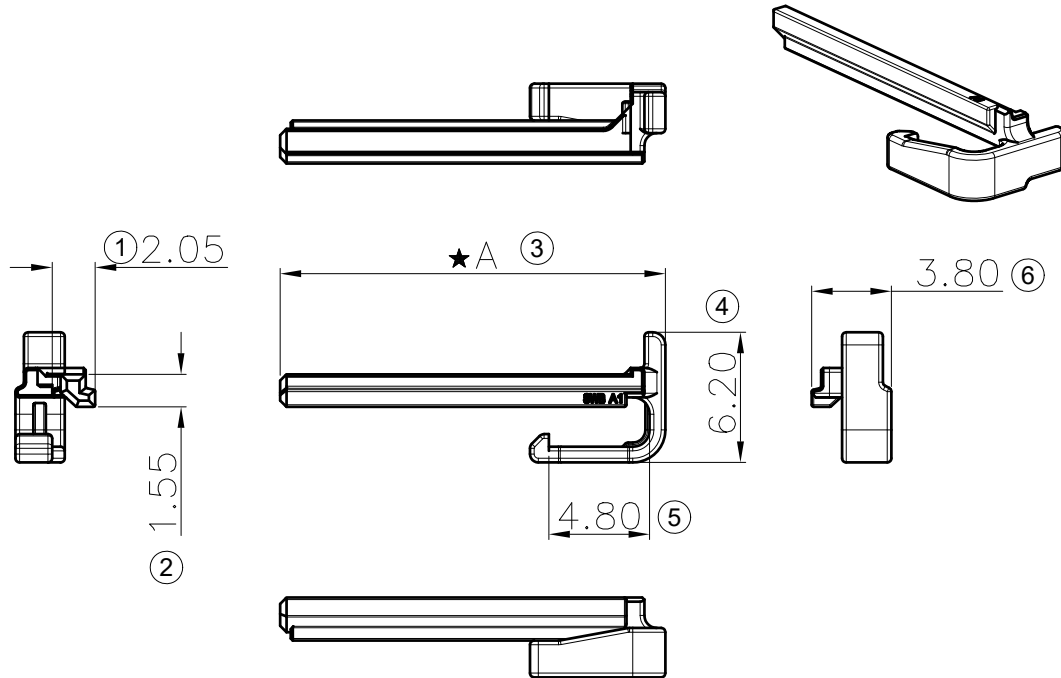

■ Specifications :

- Temperature Range:-40°C~+125°C
- Mates With ADZL Housing:A2022H-XXA
- Packaging Drawing:PK-CA2022-XXA-PTGY
- Symbols for SPC dimensions:" ★ "

CA 2022-XX A-PT GY

① ② ③ ④ ⑤ ⑥

- ① Connector Type: C-TPA
- ② Series No.: A2022
- ③ Row No.-Pin No: XX-Single Row 02~15Pin
- ④ Special No.: A-A Type
- ⑤ Plastic Material: PT-PBT-GF UL94V-0
- ⑥ Color: GY-Gray

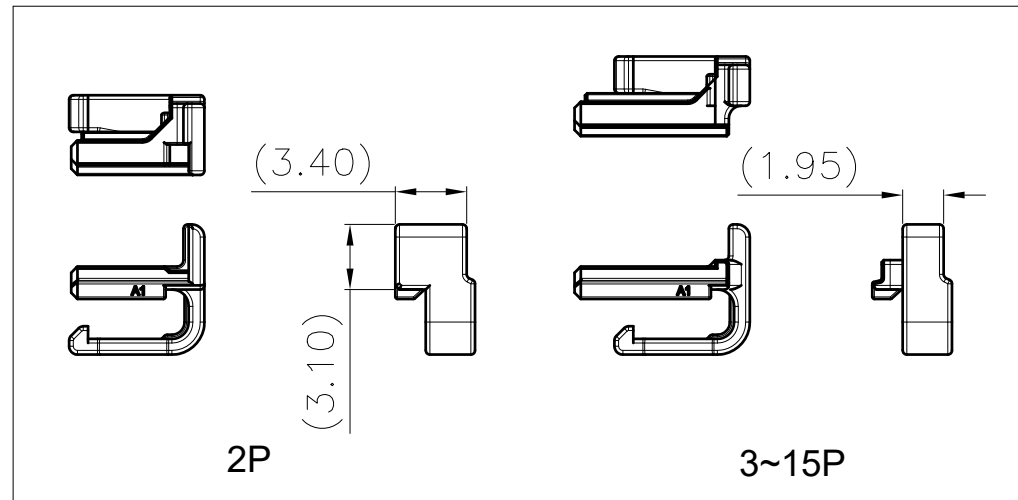

Dimensions/mm	
Part NO.	A
02	6.35
03	8.35
04	10.35
05	12.35
06	14.35
07	16.35
08	18.35
09	20.35
10	22.35
11	24.35
12	26.35
13	28.35
14	30.35
15	32.35

DATE	REV	ECN NO.	DESCRIPTION	MODIFY	APPROVAL
1					
2					
3					
4					

GENERAL TOLERANCE	
.X	±0.35
.XX	±0.25
.XXX	±0.15
X.°	±2°
PROJECT	
⊕	⊖

ADZL 东莞市思量连接器有限公司
DONGGUAN ADZL CONNECTORS CO.,LTD.

APPROVAL	CHECK	DRAWN	DATE
Ken	Zhao Hong	Allen	2022/05/25

PART NO. CA2022-XXA-PTGY				
TITLE 2.00 WTB CONN. TPA				
UNIT	SCALE	SHEET	REV	NUMBER
mm	2:1	1/1		

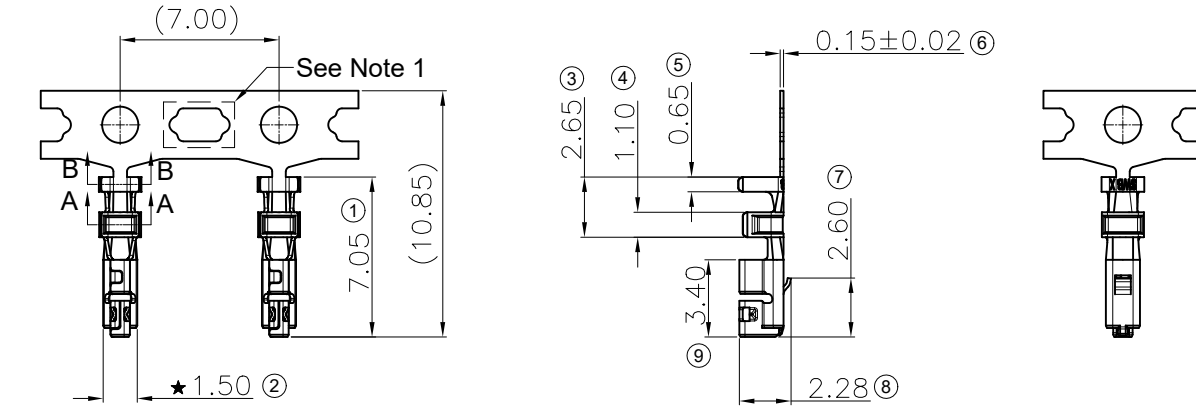

■ Specifications:

- Current Rating:3A AC/DC(0.35mm² Wire)
- Temperature Range:
High conductivity copper:-40°C~+125°C
Phosphor Bronze:-40°C~+105°C
- Contact Resistance:≤10mΩ(Initial)
≤20mΩ(After Testing)
- Mates With ADZL Housing:A2022H-XXA
- Packaging Drawing:PK-A2022T-XXX-A
- Product Specification:PS-A2022-03
- Symbols for SPC Dimensions:"★"

A2022 T - X X X - A
① ② ③ ④ ⑤ ⑥

- ① Series No.:A2022
- ② Category:T-Terminal
- ③ Material:H-High conductivity copper
P-Phosphor Bronze
- ④ Plating Code: Y2-40~120u"(1~3um) TIN
SN1-Underplate Ni 40~120u"(1~3um) ;
Top Plating Sn 80~200u"(2~5um)
- ⑤ Plating Process: B-Stamping After Plating
Blank-Stamping Before Plating
- ⑥ Special No.: A-A Type

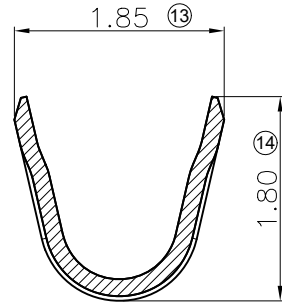
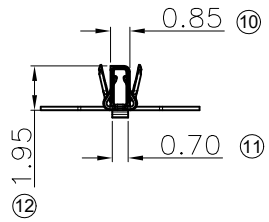

SECTION A-A
SCALE 15:1

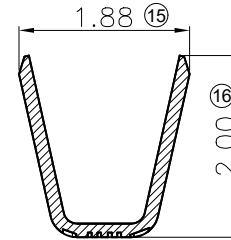

SECTION B-B
SCALE 12:1

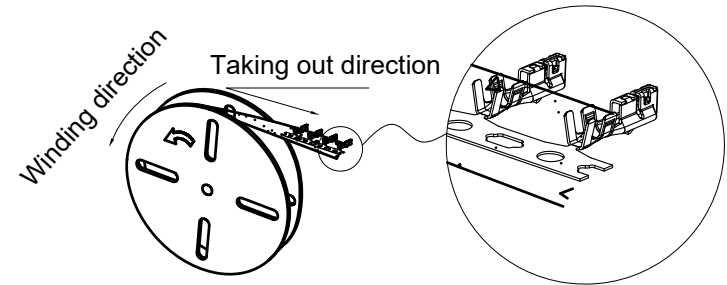
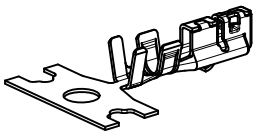

2022T-PSN1-A	0.35mm ²	Ø1.4mm Max
2022T-HY2B-A	0.35mm ²	Ø1.4mm Max
Part NO.	Wire Range	Insulation O.D.

DATE	REV	ECN NO.	DESCRIPTION	MODIFY	APPROVAL
1		2	3	4	5

GENERAL TOLERANCE				东莞市思量连接器有限公司 DONGGUAN ADZL CONNECTORS CO.,LTD.	PART NO.							
.X	±0.35				2022T-XXX-A							
.XX	±0.25				TITLE							
.XXX	±0.15				2.00 WTB crimp terminal							
X.°	±2°			APPROVAL	CHECK	DRAWN	DATE	UNIT	SCALE	SHEET	REV	NUMBER
PROJECT				Ken	Zhao Hong	Allen	2022/05/25	mm	3:1	1/1		

UNIT	SCALE	SHEET	REV	NUMBER
mm	3:1	1/1		