

**Specifications :**

- Voltage rating: 150V AC / DC
- Current rating: 1A AC / DC
- Withstanding voltage: 500V AC/minute
- Temperature range: -25°C~+85°C
- Insulation resistance: ≥500MΩ
- Contact resistance: ≤30mΩ
- After environmental testing: ≤40mΩ
- Mates With ADZL Housing :9862H

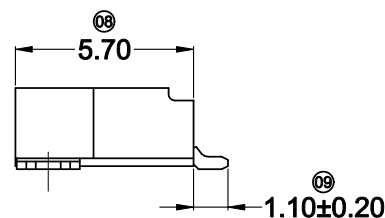
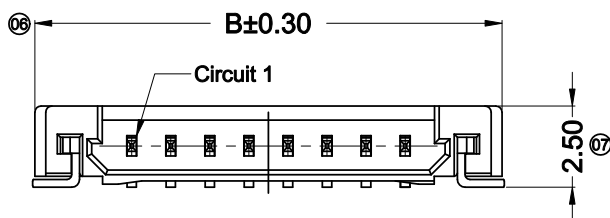

9862 W R S-XX X-XX XX XX

① ② ③ ④ ⑤ ⑥ ⑦ ⑧ ⑨

- ① Series No.
- ② Category: W-wafer
- ③ Welding Board Angle: R- Right Angle 90°
- ④ Welding Way: S-SMT
- ⑤ Row No.-Pin No.: XX-02P~30P
- ⑥ Plug the Pin & Special No.:
- ⑦ Material: 6T-PA6T 94V-0 ;LP-LCP 94V-0
- ⑧ Planting Category: SN-Matte tin plating ; SW-Matte Tin
- ⑨ Color: Blank-Natural Color

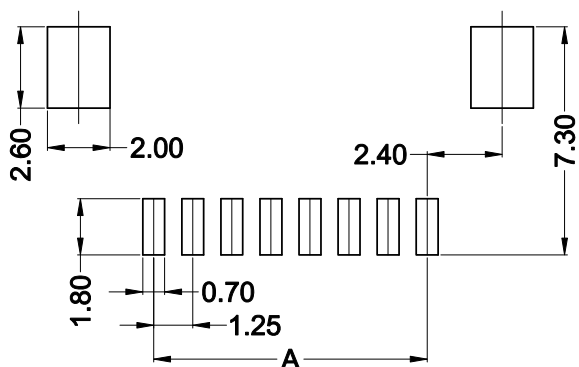

Recommended P.C.B Layout  
General Tolerance±0.05

Poles	Dimensions(mm)		Poles	Dimensions(mm)	
	A	B		A	B
02	1.25	7.45	11	12.50	18.70
03	2.50	8.70	12	13.75	19.95
04	3.75	9.95	13	15.00	21.20
05	5.00	11.20	14	16.25	22.45
06	6.25	12.45	15	17.50	23.70
07	7.50	13.70	20	23.75	29.95
08	8.75	14.95	25	30.00	36.20
09	10.00	16.20	30	36.25	42.45
10	11.25	17.45			

GENERAL TOLERANCE  
.X ±0.30  
.XX ±0.20  
.XXX ±0.10

东莞市思量连接器有限公司  
DONGGUAN ADZL CONNECTORS CO.,LTD.

PART NO. 9862WRS-XX-XXXX

TITLE 1.25mm Crimp Style Connectors

PROJECT

APPROVAL CHECK DRAWN DATA

Ken Zhao Hong Allen 2021/06/08

UNIT MM SCALE 1:1 NUMBER REV

DATE OLD REV NEW REV ECN DESCRIPTION CHECK APPROVAL

1 2 3 4 5 6 7 8

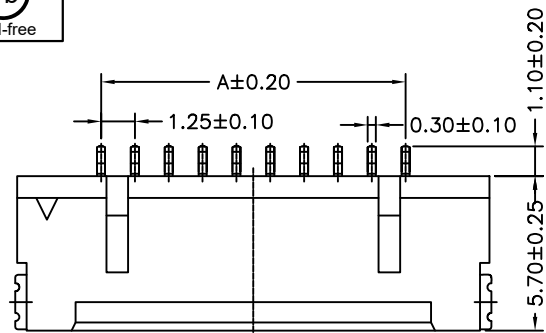

04P~30P

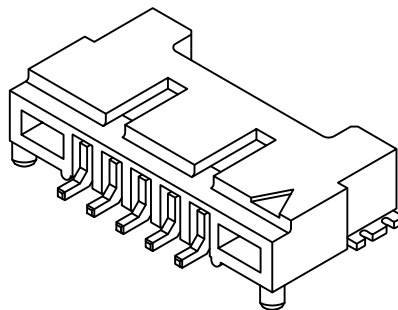

■ Specifications :

- Voltage rating: 150V AC / DC
- Current rating: 1A AC / DC
- Withstanding voltage: 500V AC/minute
- Temperature range: -35°C~+85°C
- Insulation resistance: ≥500MΩ
- Contact resistance: ≤30mΩ
- After environmental testing: ≤40mΩ

9862 W R S-XX S-XX XX XX  
① ② ③ ④ ⑤ ⑥ ⑦ ⑧ ⑨

- ① Series No.
- ② Category: W-wafer
- ③ Welding Board Angle: R- Right Angle 90°
- ④ Welding Way: S-SMT
- ⑤ Row No.-Pin No.: XX-03P~30P
- ⑥ Plug the Pin & Special No.: S-With Post
- ⑦ Material: 9T-PA9T 94V-0 LP-LCP 94V-0 ;
- ⑧ Planting Category: SN-Bright tin plating ;
- ⑨ Color: Blank-natural color

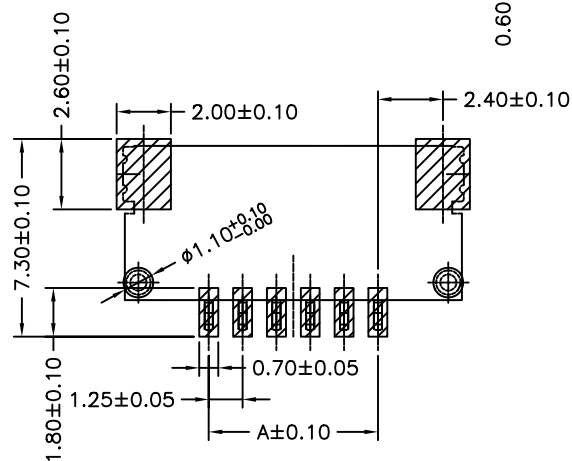
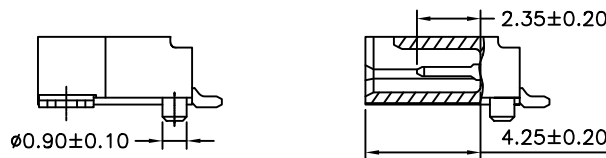
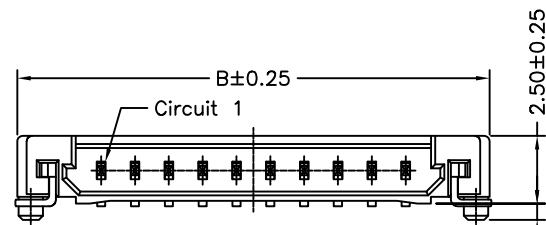

Recommended P.C.B Layout  
General Tolerance±0.05

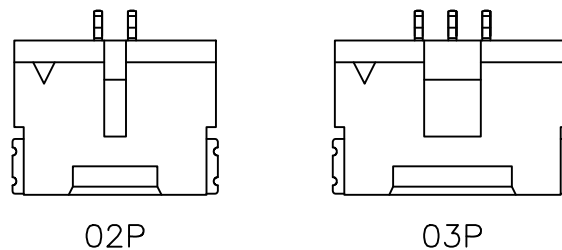

Circuit No.	Dimensions		Circuit No.	Dimensions	
	A	B		A	B
02P	1.25	7.45	11P	12.50	18.70
03P	2.50	8.70	12P	13.75	19.95
04P	3.75	9.95	13P	15.00	21.20
05P	5.00	11.20	14P	16.25	22.45
06P	6.25	12.45	15P	17.50	23.70
07P	7.50	13.70	20P	23.75	29.95
08P	8.75	14.95	21P	25.00	31.20
09P	10.00	16.20	25P	30.00	36.20
10P	11.25	17.45	30P	36.25	42.45

9862WRS-XXS-LPSN	LCP UL 94V-0	Phosphor Bronze	Tin-Plated	9862H
9862WRS-XXS-9TSN	PA9T UL 94V-0	Phosphor Bronze		
PART NO	Material	Material(Pin And Solder Tabs)	Finish(Pin And Solder Tabs)	Mates With ADZL Housing

GENERAL TOLERANCE

.X	±0.30
.XX	±0.20
.XXX	±0.10

 东莞市思量连接器有限公司  
DONGGUAN ADZL CONNECTORS CO.,LTD.

PART NO.  
9862WRS-XXS-XXXX

TITLE  
1.25mm Crimp Style Connectors

APPROVAL CHECK DRAWN DATA

Ken Zhao Hong Allen 2018/11/20

UNIT SCALE NUMBER REV  
MM 1 : 1

DATE	OLD REV	NEW REV	ECN	DESCRIPTION	CHECK	APPROVAL

PROJECT  

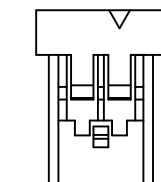
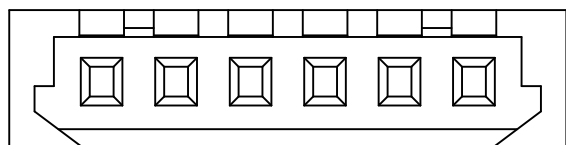
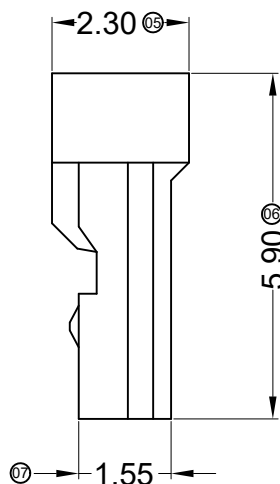
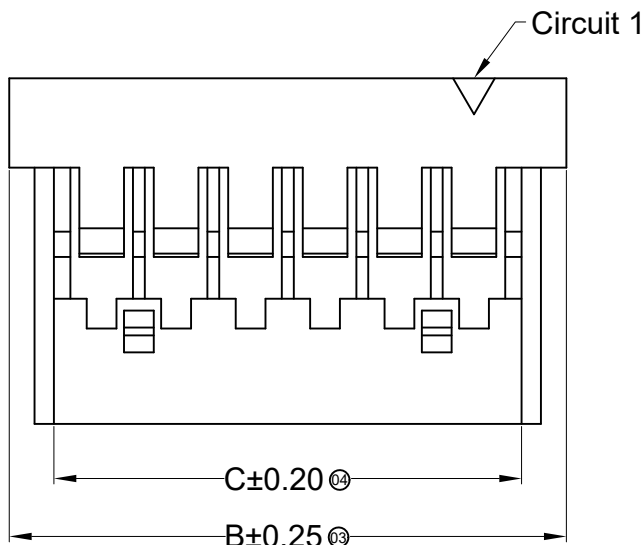
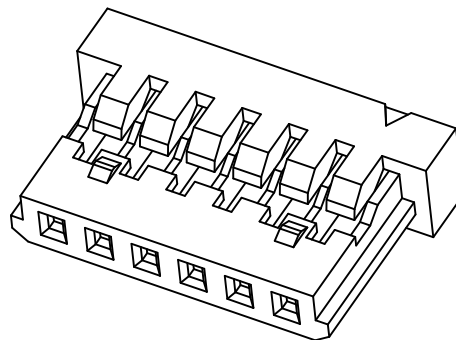
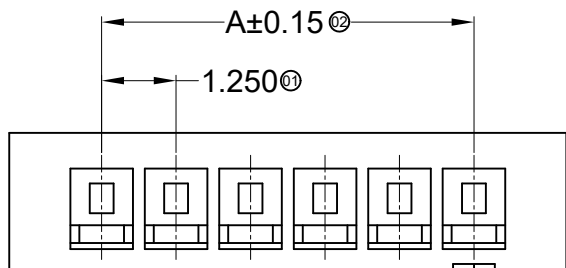
02P Single Salient  
Scale 1:2

■ Specifications :

- Voltage rating: 150V AC / DC
- Current rating: 1A AC / DC
- Withstanding voltage: 500V AC/minute
- Temperature range: -25°C~+85°C
- Insulation resistance: ≥500MΩ
- Contact resistance: ≤30mΩ
- After environmental testing: ≤40mΩ

9862 H X-XX X-N0 HF XX  
① ② ③ ④ ⑤ ⑥ ⑦ ⑧

- ① Series No.
- ② Category: H-HSG
- ③ Welding Board Angle: Blank-ordinary
- ④ Row No.-Pin No.: XX-02P~30P
- ⑤ Plug the Pin & special No.:
- ⑥ Material: N0-PA66 94V-0
- ⑦ HF-Halogen Free
- ⑧ Color: Blank-Natural color BK-Black color

Poles	Dimensions(mm)			Poles	Dimensions(mm)		
	A	B	C		A	B	C
02	1.25	4.35	2.85	11	12.50	15.60	14.10
03	2.50	5.60	4.10	12	13.75	16.85	15.35
04	3.75	6.85	5.35	13	15.00	18.10	16.60
05	5.00	8.10	6.60	14	16.25	19.35	17.85
06	6.25	9.35	7.85	15	17.50	20.60	19.10
07	7.50	10.60	9.10	20	23.75	26.85	25.35
08	8.75	11.85	10.35	25	30.00	33.10	31.60
09	10.00	13.10	11.60	30	36.25	39.35	37.85
10	11.25	14.35	12.85				

9862H-XX-N0HF	PA66 UL 94V-0 Halogen Free	9862T	9862W
9862H-XX-N0	PA66 UL 94V-0		
PART NO	Material	Suitable ADZL Terminal	Mates With ADZL Wafer

DATE	OLD REV	NEW REV	ECN	DESCRIPTION	CHECK	APPROVAL

GENERAL TOLERANCE	
.X	±0.30
.XX	±0.20
.XXX	±0.10
PROJECT	

 东莞市思量连接器有限公司 DONGGUAN ADZL CONNECTORS CO.,LTD.			
APPROVAL	CHECK	DRAWN	DATA
Ken	Zhao Hong	Allen	2017/07/20

PART NO. 9862H-XX-N0XX			
TITLE 1.25mm Crimp Style Connectors			
UNIT MM	SCALE 1:1	NUMBER	REV

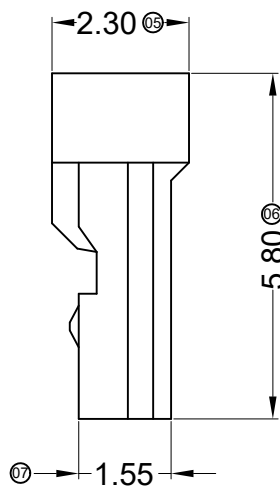
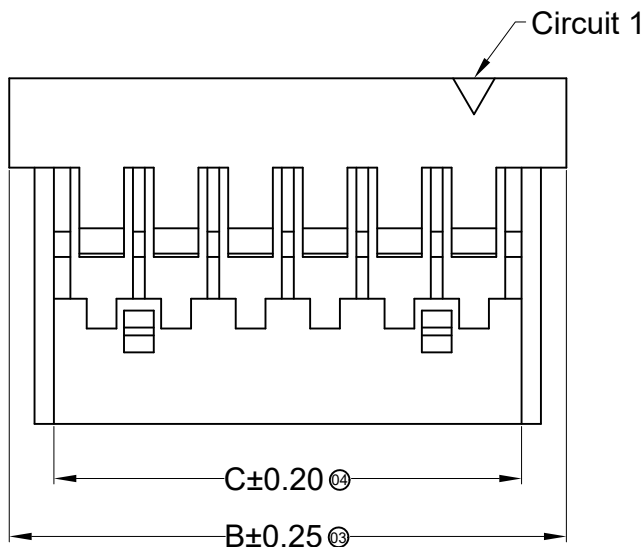
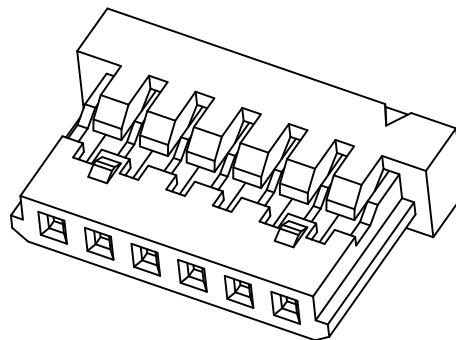
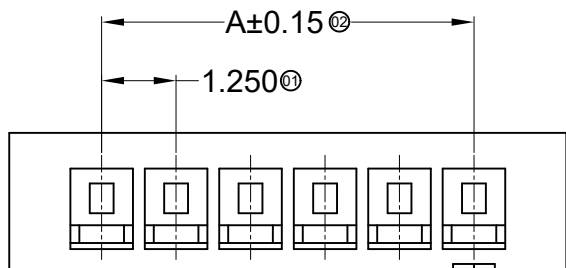

03P~30P Double Salient

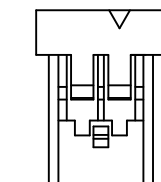
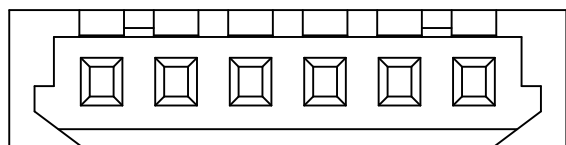

02P Single Salient  
Scale 1:2

■ Specifications :

- Voltage rating: 150V AC / DC
- Current rating: 1A AC / DC
- Withstanding voltage: 500V AC/minute
- Temperature range: -25°C~+85°C
- Insulation resistance: ≥500MΩ
- Contact resistance: ≤30mΩ
- After environmental testing: ≤40mΩ

9862 H X-XX X-N0 HF - XX - 01  
① ② ③ ④ ⑤ ⑥ ⑦ ⑧ ⑨

- ① Series No.
- ② Category: H-HSG
- ③ Welding Board Angle: Blank-ordinary
- ④ Row No.-Pin No.: XX-02P~30P
- ⑤ Plug the Pin & special No.:
- ⑥ Material: N0-PA66 94V-0
- ⑦ HF-Halogen Free
- ⑧ Color: Blank-Natural color BK-Black color
- ⑨ Numbering

Poles	Dimensions(mm)			Poles	Dimensions(mm)		
	A	B	C		A	B	C
02	1.25	4.35	2.85	11	12.50	15.60	14.10
03	2.50	5.60	4.10	12	13.75	16.85	15.35
04	3.75	6.85	5.35	13	15.00	18.10	16.60
05	5.00	8.10	6.60	14	16.25	19.35	17.85
06	6.25	9.35	7.85	15	17.50	20.60	19.10
07	7.50	10.60	9.10	20	23.75	26.85	25.35
08	8.75	11.85	10.35	25	30.00	33.10	31.60
09	10.00	13.10	11.60	30	36.25	39.35	37.85
10	11.25	14.35	12.85				

9862H-XX-N0HF-01	PA66 UL 94V-0 Halogen Free	9862T	9862W
9862H-XX-N0-01	PA66 UL 94V-0		
PART NO	Material	Suitable ADZL Terminal	Mates With ADZL Wafer

DATE	OLD REV	NEW REV	ECN	DESCRIPTION	CHECK	APPROVAL

GENERAL TOLERANCE	
.X	±0.30
.XX	±0.20
.XXX	±0.10
PROJECT	

 东莞市思量连接器有限公司 DONGGUAN ADZL CONNECTORS CO.,LTD.			
APPROVAL	CHECK	DRAWN	DATA
Ken	Zhao Hong	Allen	2018/05/23

PART NO. 9862H-XX-N0XX-01			
TITLE 1.25mm Crimp Style Connectors			
UNIT MM	SCALE 1:1	NUMBER	REV

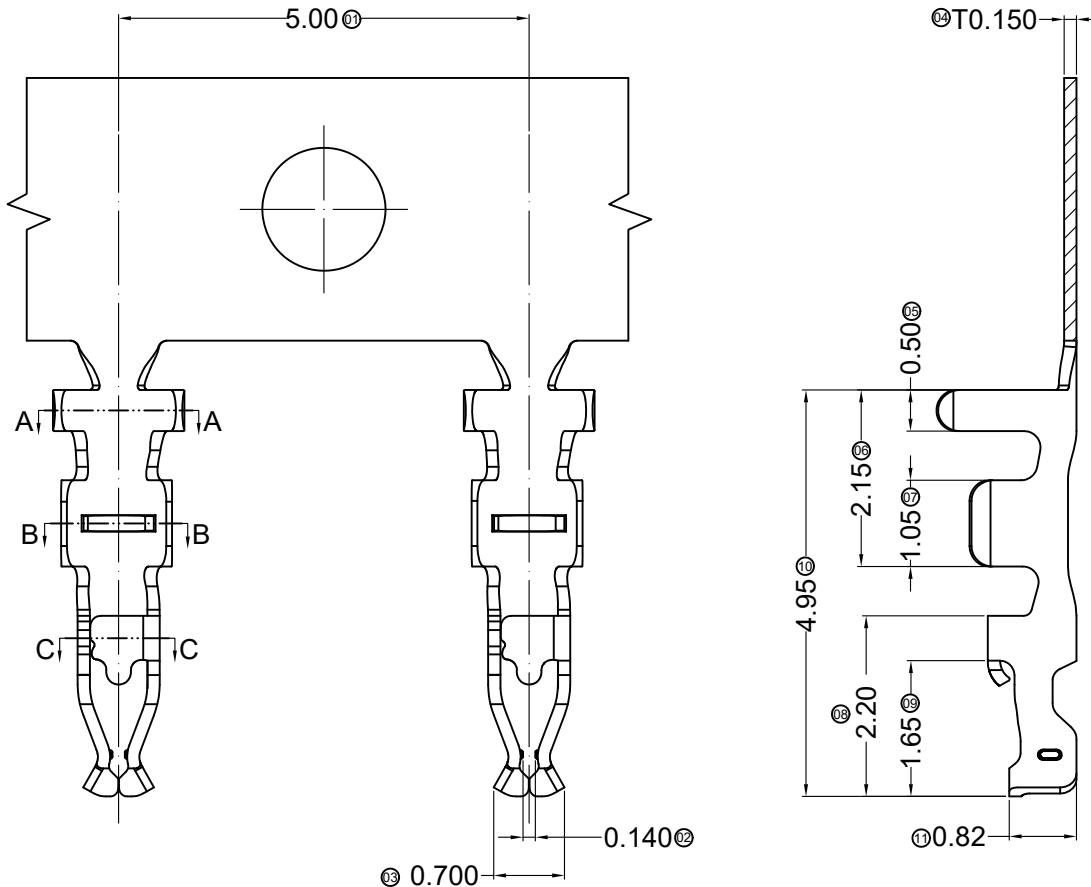

■ Specifications :

- Voltage rating: 150V AC / DC
- Current rating: 1A AC / DC
- Withstanding voltage: 500V AC/minute
- Temperature range: -25°C~+85°C
- Insulation resistance:≥500MΩ
- Contact resistance: ≤30mΩ
- After environmental testing: ≤40mΩ

9862 T X-P XXX X-X  
① ② ③ ④ ⑤ ⑥ ⑦

- ① Series Number
- ② Category: T-terminal
- ③ Shape: Blank-ordinary
- ④ Material: P-Phosphor bronze
- ⑤ Plating style: V01-Gold Flash ; SN-Bright tin plating ;
- ⑥ Plating method: Blank-Stamping before plating
- ⑦ Mold No./Mark/Special No.

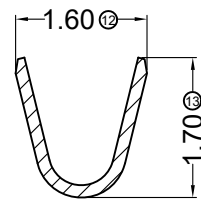
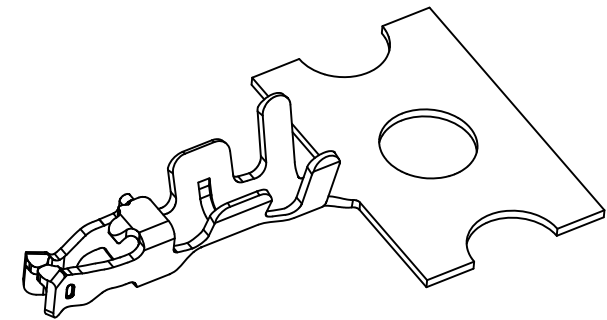

SECTION: A-A  
SCALE: 1:1

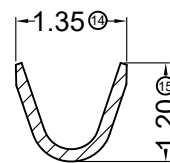

SECTION: B-B  
SCALE: 1:1

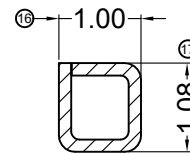

SECTION: C-C  
SCALE: 1:1

9862T-PV01	Phosphor Bronze	AWG#26-32	1.00mm(Max)	Stamping Before Pating:30u" Ni;Whole Gold :Gold Flash	9862H
9862T-PSN				Stamping Before Pating:30u" Ni;70u"Sn Min.	
PART NO	Material	Wire Range	Insulation O.D.	Finish	Used In ADZL Housing

DATE	OLD REV	NEW REV	ECN	DESCRIPTION	CHECK	APPROVAL

GENERAL TOLERANCE  
.X ±0.30  
.XX ±0.20  
.XXX ±0.10



东莞市思量连接器有限公司  
DONGGUAN ADZL CONNECTORS CO.,LTD.

APPROVAL	CHECK	DRAWN	DATA
Ken	Zhao Hong	Allen	2021/12/27

PART NO.			
9862T-PXXX			
TITLE			
1.25mm Crimp Style Connectors			
UNIT	SCALE	NUMBER	REV
MM	1:1		