

■ Specifications :

- Voltage rating: 125V AC / DC
- Current rating: 1A AC / DC
- Withstanding voltage: 250V AC/minute
- Temperature range: -25°C~+85°C
- Insulation resistance: ≥100MΩ
- Contact resistance: ≤20mΩ
- After environmental testing: ≤40mΩ

9827 W R S-XX XX-XX V01 XX  
① ② ③ ④ ⑤ ⑥ ⑦ ⑧ ⑨

- ① Series No.
- ② Category: W-wafer
- ③ Welding Board Angle: R- Right Angle 90°
- ④ Welding Way: S-SMT
- ⑤ Row No.-Pin No.: XX-02P~30P
- ⑥ Plug the Pin & Special No.: HF-Halogen Free
- ⑦ Material: 6T-PA6T 94V-0 ; 9T-PA9T 94V-0 ; 1T-PA10T
- ⑧ Planting Category: V01-Gold Flash
- ⑨ Color: Blank-natural color

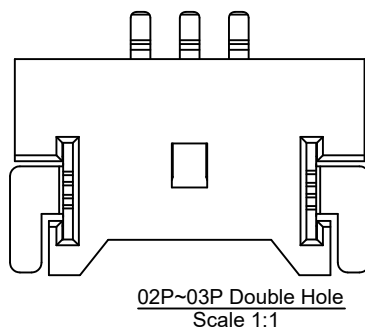
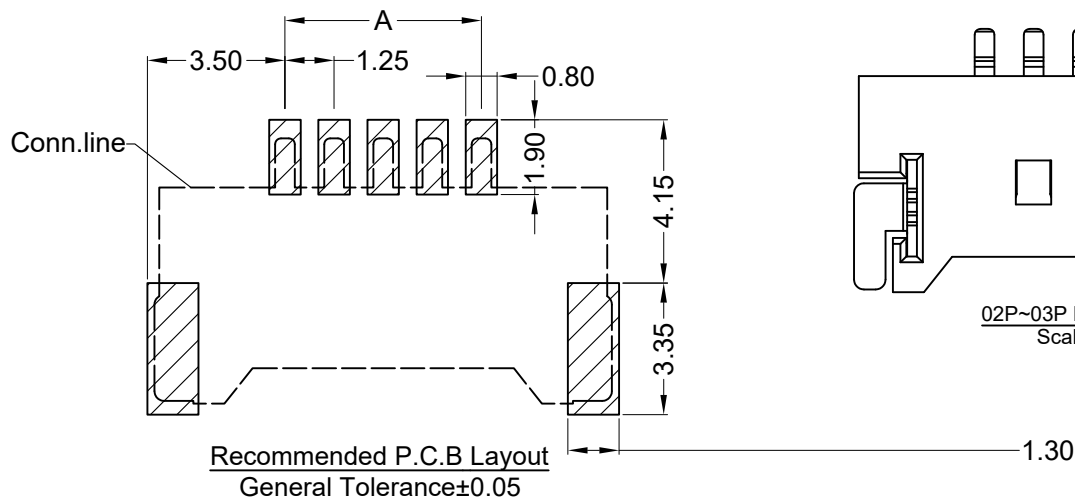
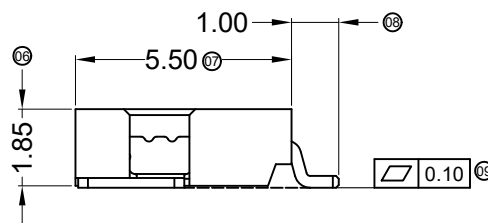
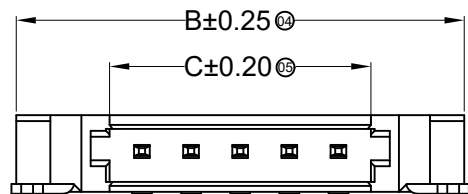

Poles	Dimensions(mm)			Poles	Dimensions(mm)		
	A	B	C		A	B	C
02	1.25	7.65	2.90	10	11.25	17.65	12.90
03	2.50	8.90	4.15	11	12.50	18.90	14.15
04	3.75	10.15	5.40	12	13.75	20.15	15.40
05	5.00	11.40	6.65	13	15.00	21.40	16.65
06	6.25	12.65	7.90	14	16.25	22.65	17.90
07	7.50	13.90	9.15	15	17.50	23.90	19.15
08	8.75	15.15	10.40	16	18.75	25.15	20.40
09	10.00	16.40	11.65	20	23.75	30.15	25.40
				30	36.25	42.65	37.90

9827WRS-XX-1TV01	PA10T UL 94V-0	Phorphos bronze	Gold-Flash	Phorphos bronze	Gold-Flash	9827H
9827WRS-XX-6TV01	PA6T UL 94V-0					
9827WRS-XX-9TV01	PA9T UL 94V-0					
PART NO	Material	Material(Pin)	Finish(Pin)	Material (Solder Tabs)	Finish (Solder Tabs)	Mates With ADZL Housing

DATE	OLD REV	NEW REV	ECN	DESCRIPTION	CHECK	APPROVAL

GENERAL TOLERANCE	
.X	±0.30
.XX	±0.20
.XXX	±0.10

东莞市思量连接器有限公司  
DONGGUAN ADZL CONNECTORS CO.,LTD.

APPROVAL	CHECK	DRAWN	DATE
Ken	Zhao hong	Allen	2023/02/02

PART NO. 9827WRS-XX-XTV01			
TITLE 1.25mm Crimp Style Connectors			
UNIT MM	SCALE 1:1	NUMBER	REV

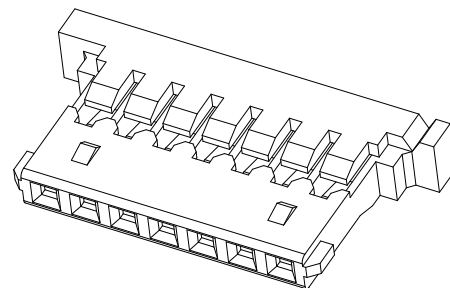
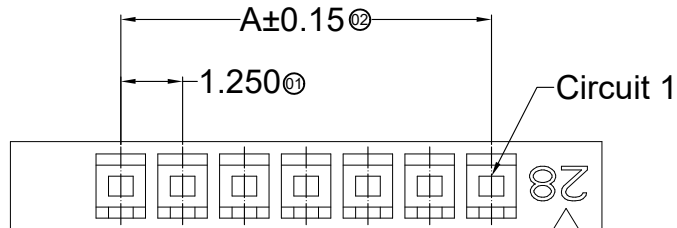

**Specifications :**

- Voltage rating: 125V AC / DC
- Current rating: 1A AC / DC
- Withstanding voltage: 250V AC/minute
- Temperature range: -25°C~+85°C
- Insulation resistance: ≥100MΩ
- Contact resistance: ≤20mΩ
- After environmental testing: ≤40mΩ

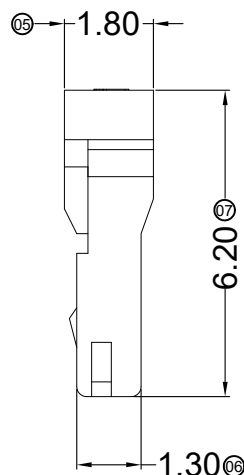
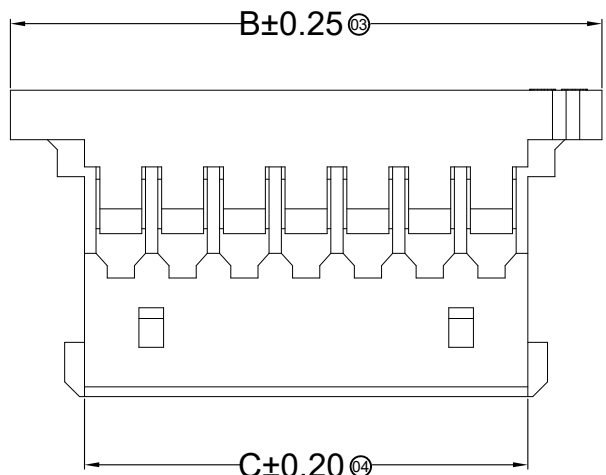

04P~30P Double Salient  
Scale 1:1

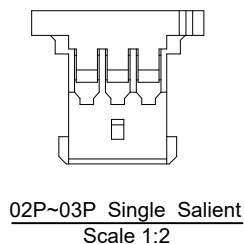

9827 H X-XX X-N0 HF XX  
① ② ③ ④ ⑤ ⑥ ⑦ ⑧

- ① Series No.
- ② Category: H-HSG
- ③ Welding Board Angle: Blank-ordinary
- ④ Row No.-Pin No.: XX-02P~30P
- ⑤ Plug the Pin & special No.:
- ⑥ Material: N0-PA66 94V-0
- ⑦ HF-Halogen free
- ⑧ Color: Blank-natural color; BK-Black

Poles	Dimensions(mm)			Poles	Dimensions(mm)		
	A	B	C		A	B	C
02	1.25	5.72	2.72	11	12.50	16.97	13.97
03	2.50	6.97	3.97	12	13.75	18.22	15.22
04	3.75	8.22	5.22	13	15.00	19.47	16.47
05	5.00	9.47	6.47	14	16.25	20.72	17.72
06	6.25	10.72	7.72	15	17.50	21.97	18.97
07	7.50	11.97	8.97	16	18.75	23.22	20.22
08	8.75	13.22	10.22	20	23.75	28.22	25.22
09	10.00	14.47	11.47	25	30.00	34.47	31.47
10	11.25	15.72	12.72	30	36.25	40.72	37.72

9827H-XX-N0BK	Nylon 66 UL 94V-0 Black	9827T	9827W
9827H-XX-N0HF	Nylon 66 UL 94V-0 Halogen-Free		
9827H-XX-N0	Nylon 66 UL 94V-0		
PART NO	Material	Suitable ADZL Terminal	Mates With ADZL Wafer

DATE	OLD REV	NEW REV	ECN	DESCRIPTION	CHECK	APPROVAL

GENERAL TOLERANCE	
.X	±0.30
.XX	±0.20
.XXX	±0.10

**ADZL** 东莞市思量连接器有限公司  
DONGGUAN ADZL CONNECTORS CO.,LTD.

APPROVAL	CHECK	DRAWN	DATA
Ken	Zhao hong	Allen	2014/05/17

PART NO. 9827H-XX-N0XX			
TITLE 1.25mm Crimp Style Connectors			
UNIT MM	SCALE 1:1	NUMBER	REV



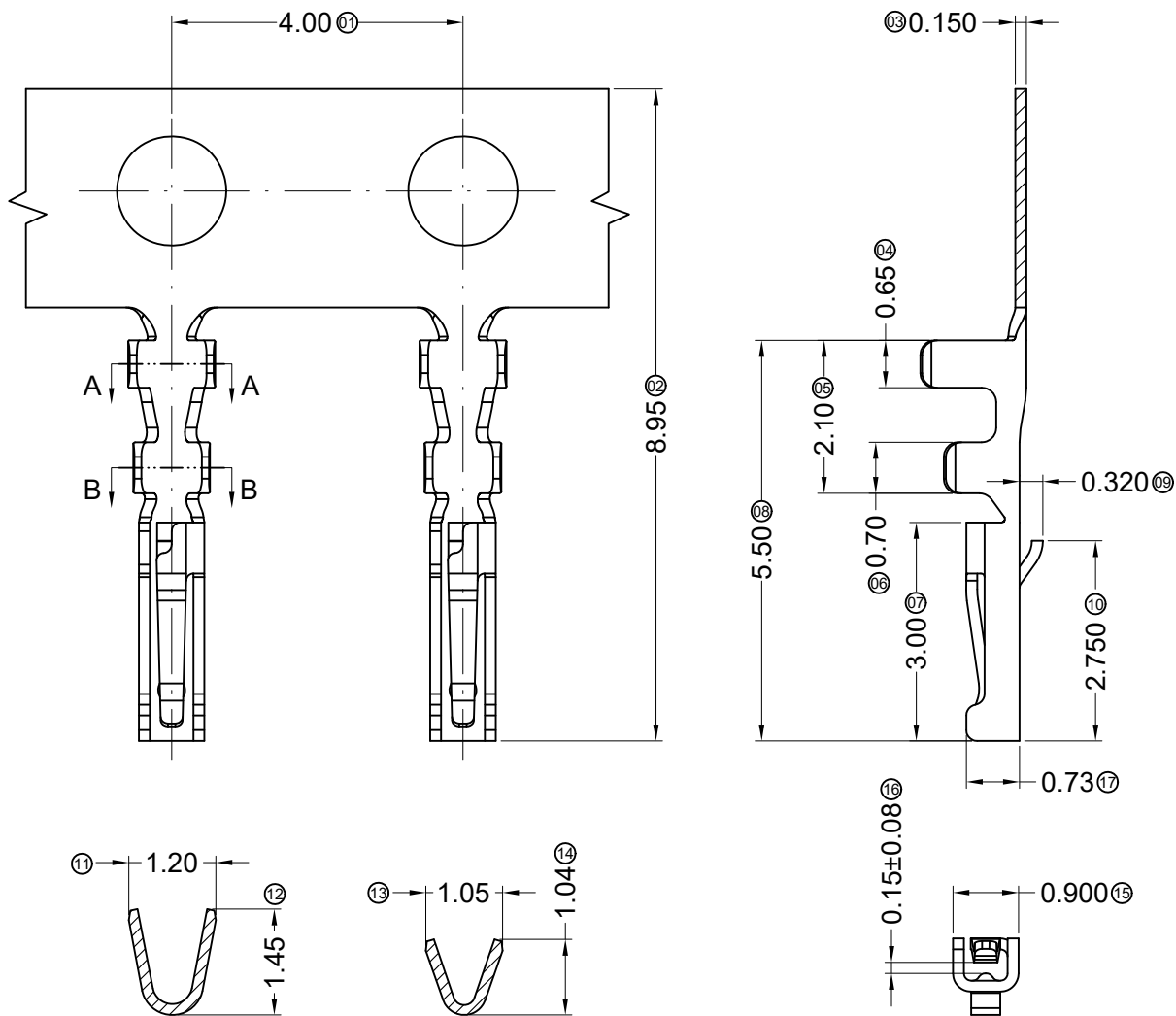

■ Specifications :

- Voltage rating: 125V AC / DC
- Current rating: 1A AC / DC
- Withstanding voltage: 250V AC/minute
- Temperature range: -25°C~+85°C
- Insulation resistance: ≥100MΩ
- Contact resistance: ≤20mΩ
- After environmental testing: ≤40mΩ

9827 T X-P XX X-X

① ② ③ ④ ⑤ ⑥ ⑦

- ① Series Number
- ② Category: T-terminal
- ③ Shape: Blank-ordinary
- ④ Material: P-Phosphor bronze
- ⑤ Plating style: V01-Gold Flash ; V03-Gold 3u"  
SN-Bright tin plating 70u"Min.;  
SN1-Bright tin plating 100u"Min.
- ⑥ Plating method: Blank-Stamping before plating
- ⑦ Mold No./Mark/Special No.

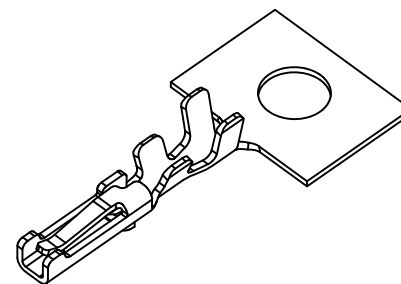

9827T-PV01	Phosphor Bronze	AWG#28-32	0.90mm(Max)	Stamping Before Pating:30u" Ni;Whole Gold :Gold Flash	9827H
9827T-PSN	Phosphor Bronze	AWG#28-32	0.90mm(Max)	Stamping Before Pating:30u" Ni;70u"Sn Min.	
PART NO	Material	Wire Range	Insulation O.D.	Finish	Used In ADZL Housing

GENERAL TOLERANCE						
.X ±0.30						
.XX ±0.20						
.XXX ±0.10						
PROJECT						
DATE	OLD REV	NEW REV	ECN	DESCRIPTION	CHECK	APPROVAL

ADZL 东莞市思量连接器有限公司  
DONGGUAN ADZL CONNECTORS CO.,LTD.

APPROVAL	CHECK	DRAWN	DATA
Ken	Zhao hong	Allen	2018/05/21

PART NO. 9827T-PXXX			
TITLE 1.25mm Crimp Style Connectors			
UNIT MM	SCALE 1:1	NUMBER	REV

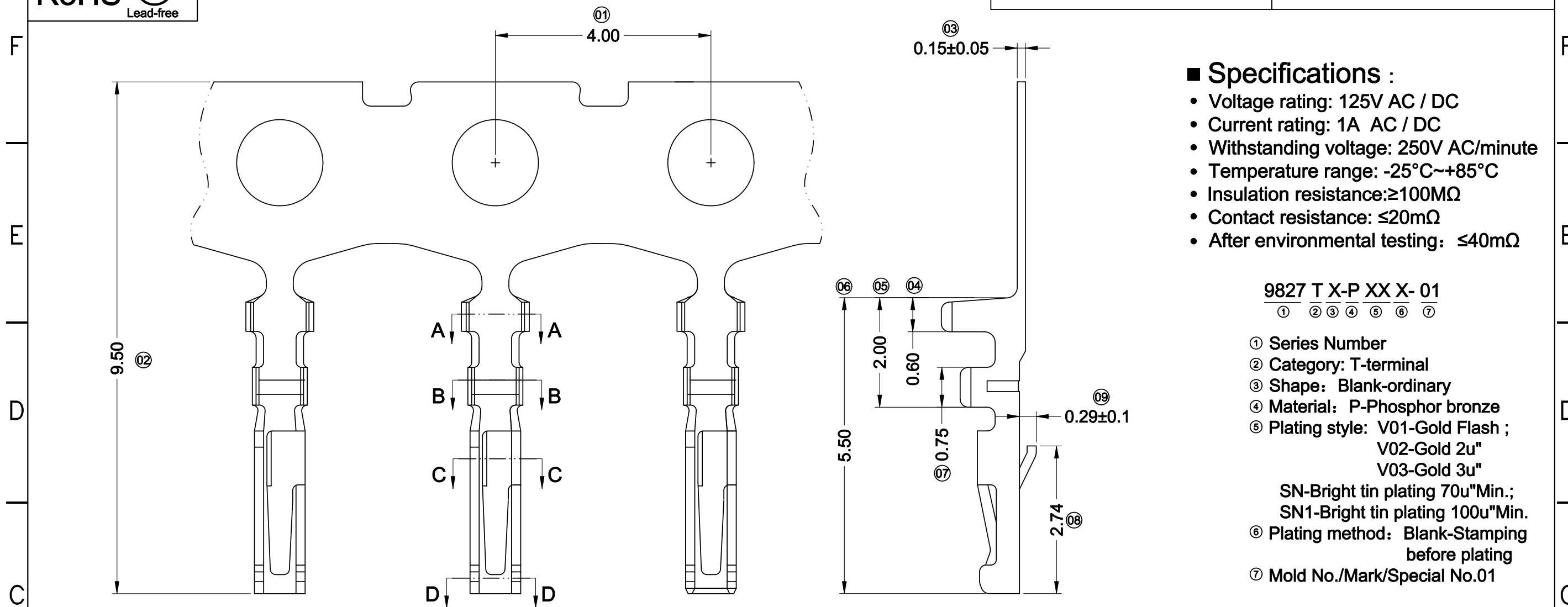

**Specifications :**

- Voltage rating: 125V AC / DC
- Current rating: 1A AC / DC
- Withstanding voltage: 250V AC/minute
- Temperature range: -25°C~+85°C
- Insulation resistance: ≥100MΩ
- Contact resistance: ≤20mΩ
- After environmental testing: ≤40mΩ

9827 T X-P XX X- 01  
① ② ③ ④ ⑤ ⑥ ⑦

- ① Series Number
- ② Category: T-terminal
- ③ Shape: Blank-ordinary
- ④ Material: P-Phosphor bronze
- ⑤ Plating style: V01-Gold Flash ;  
V02-Gold 2u"  
V03-Gold 3u"
- SN-Bright tin plating 70u"Min.;  
SN1-Bright tin plating 100u"Min.
- ⑥ Plating method: Blank-Stamping  
before plating
- ⑦ Mold No./Mark/Special No.01

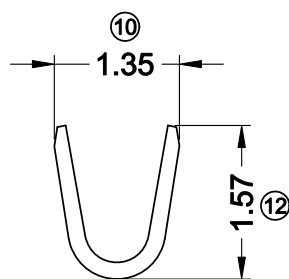

SECTION: A-A  
SCALE: 1:1

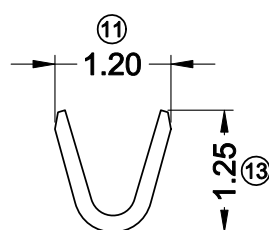

SECTION: B-B  
SCALE: 1:1

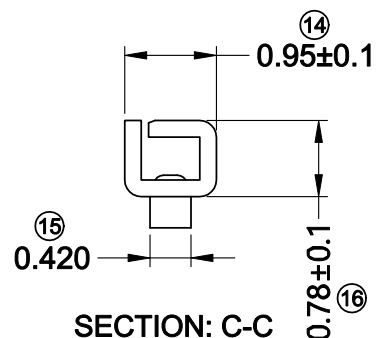

SECTION: C-C  
SCALE: 1:1

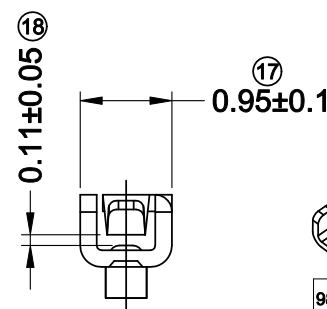

SECTION: D-D  
SCALE: 1:1

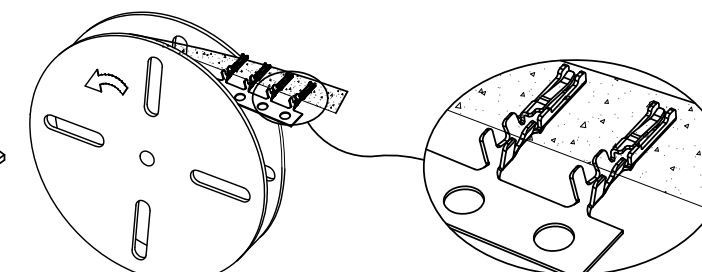
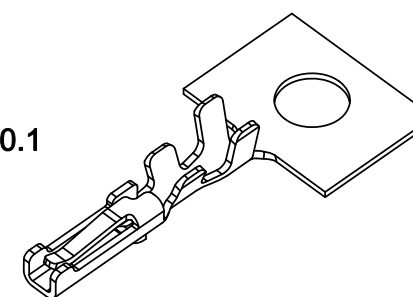

卷装方式

SCALE 4:1

9827T-PV01-01	Phosphor Bronze	AWG#28-32	0.90mm(Max)	Stamping Before Pating:30u" Ni;Whole Gold :Gold Flash	9827H
9827T-PSN-01	Phosphor Bronze	AWG#28-32	0.90mm(Max)	Stamping Before Plating:30u" Ni;70u"Sn Min.	
PART NO	Material	Wire Range	Insulation O.D.	Finish	Used In ADZL Housing

DATE	OLD REV	NEW REV	ECN	DESCRIPTION	CHECK	APPROVAL	PROJECT		

GENERAL TOLERANCE	
.X	±0.30
.XX	±0.20
.XXX	±0.10
PROJECT	Ken

 <b>东莞市思量连接器有限公司</b> DONGGUAN ADZL CONNECTORS CO.,LTD.			
APPROVAL	CHECK	DRAWN	DATA
Ken	Zhao hong	Allen	2018/05/21

PART NO. 9827T-PXX-01			
TITLE 1.25mm Crimp Style Connectors			
UNIT MM	SCALE 1:1	NUMBER	REV