

Specifications :

- Voltage rating: 50V AC / DC
- Current rating: 2.0A AC / DC
- Withstanding voltage: 500V AC/minute
- Temperature range: -25°C~+85°C
- Insulation resistance: ≥100MΩ
- Contact resistance: ≤20mΩ
- After environmental testing: ≤40mΩ

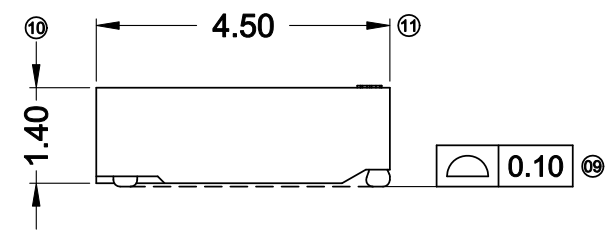
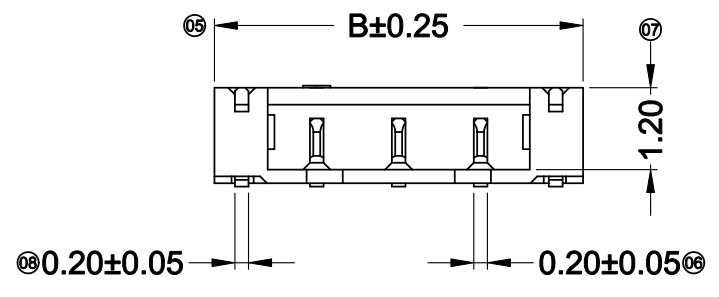

1224 W R S-XX X- XX V01 XX- N

① ② ③ ④ ⑤ ⑥ ⑦ ⑧ ⑨ ⑩

- ① Series No.
- ② Category: W-wafer
- ③ Welding Board Angle: R-Right Angle 90°
- ④ Welding Way: S-SMT
- ⑤ Row No.-Pin No.: XX-04P~07P
- ⑥ Plug the Pin & Special NO.:
- ⑦ Material: 4T-PA4T - 94V0
- ⑧ Planting Category: V01: All Gold Flash
- ⑨ Color: Blank- Black Color
- ⑩ Mark : N- No Mark

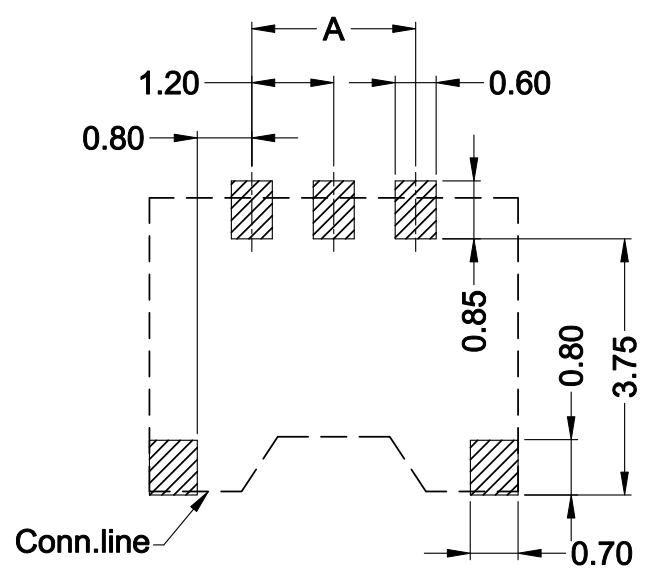

Recommended P.C.B Layout
General Tolerance±0.05

Poles	Dimensions(mm)		
	A	B	C
02	1.20	4.20	2.64
03	2.40	5.40	3.84

1224WRS-XX-4TV01-N	PA4T UL 94V-0	Phorphos Bronze	Gold-Flash	Brass	Matte Tin Plating	1224H
PART NO	Material	Material(Pin)	Finish(Pin)	Material (Solder Tabs)	Finish (Solder Tabs)	Mates With ADZL Housing

							GENERAL TOLERANCE		 东莞市思量连接器有限公司 DONGGUAN ADZL CONNECTORS CO.,LTD.				PART NO. 1224WRS-XX-XXV01-N			
							.X ±0.30 .XX ±0.20 .XXX ±0.10						TITLE 1.20mm Crimp Style Connectors			
DATE	OLD REV	NEW REV	ECN	DESCRIPTION	CHECK	APPROVAL	PROJECT	APPROVAL	CHECK	DRAWN	DATA	UNIT	SCALE	NUMBER	REV	
							Ken	Zhao Hong	Allen	2024/06/26		MM	1:1			

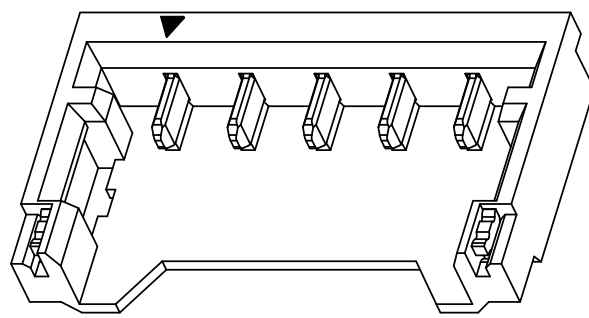
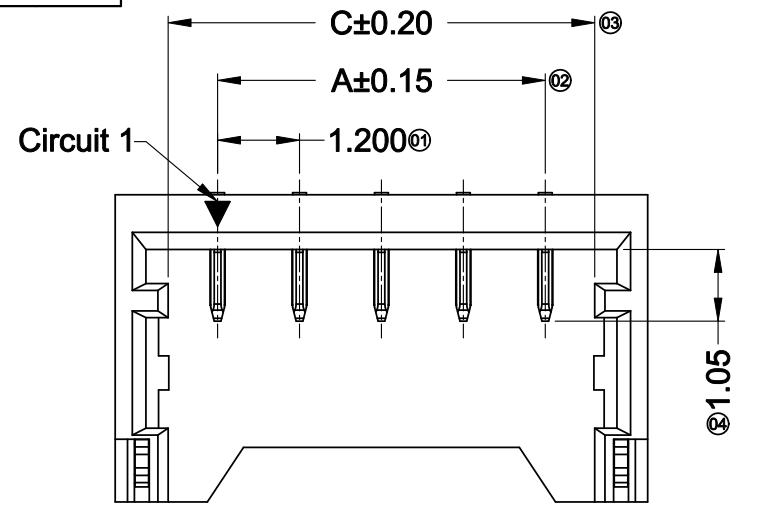

Specifications :

- Voltage rating: 50V AC / DC
- Current rating: 2.0A AC / DC
- Withstanding voltage: 500V AC/minute
- Temperature range: -25°C~+85°C
- Insulation resistance: ≥100MΩ
- Contact resistance: ≤20mΩ
- After environmental testing: ≤40mΩ

1224 W R S-XX L- XX V01 XX-N

① ② ③ ④ ⑤ ⑥ ⑦ ⑧ ⑨ ⑩

- ① Series No.
- ② Category: W-wafer
- ③ Welding Board Angle: R-Right Angle 90°
- ④ Welding Way: S-SMT
- ⑤ Row No.-Pin No.: XX-04P~07P
- ⑥ Plug the Pin & Special NO.: L-36 Edition
- ⑦ Material: 4T-PA4T 94V-0
- ⑧ Planting Category: V01: All Gold Flash
- ⑨ Color: Blank-Black Color
- ⑩ Mark : N- No Mark

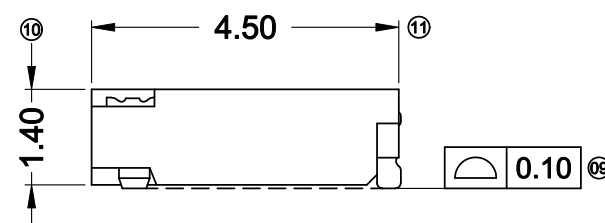
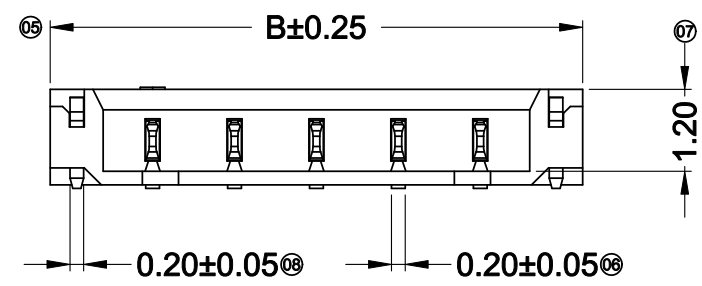

4-5P Without Sticking Point

6P With Sticking Point
Scale 1:1

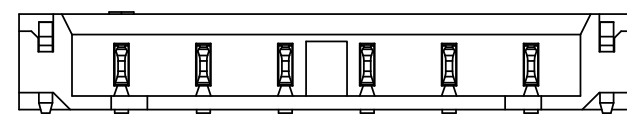

7~10P With Sticking Point
Scale 1:1

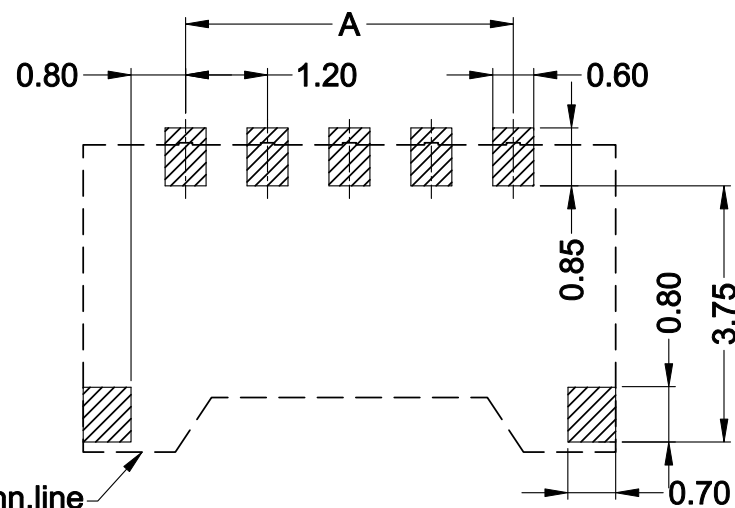
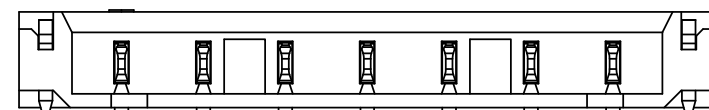

Recommended P.C.B Layout
General Tolerance±0.05

Poles	Dimensions(mm)		
	A	B	C
04	3.60	6.60	5.04
05	4.80	7.80	6.24
06	6.00	9.00	7.44
07	7.20	10.20	8.64
08	8.40	11.40	9.84
09	9.60	12.60	11.04
10	10.80	13.80	12.24

1224WRS-XXL-4TV01-N	PA4T UL 94V-0	Phorphos Bronze	Gold-Flash	Brass	Matte Tin Plating	1224H
PART NO	Material	Material(Pin)	Finish(Pin)	Material (Solder Tabs)	Finish (Solder Tabs)	Mates With ADZL Housing

				GENERAL TOLERANCE				 东莞市思量连接器有限公司 DONGGUAN ADZL CONNECTORS CO.,LTD.				PART NO. 1224WRS-XXL-XXV01-N					
				.X ±0.30 .XX ±0.20 .XXX ±0.10								TITLE 1.20mm Crimp Style Connectors					
				PROJECT				APPROVAL		CHECK		DRAWN		DATA			
DATE				OLD REV		NEW REV		ECN		DESCRIPTION				CHECK		APPROVAL	
1				2		3		4		5		6		7		8	
				Ken				Zhao Hong		Allen		2024/06/26		UNIT MM		SCALE 1:1	
														NUMBER		REV	

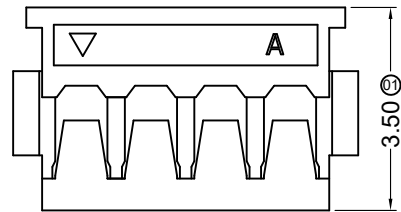

2~5Pin Shape

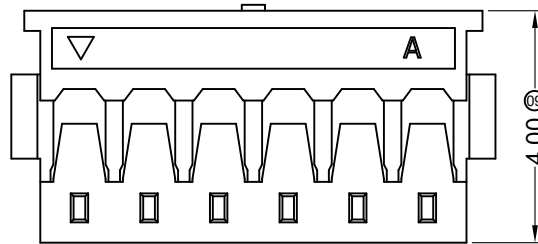

6Pin Shape

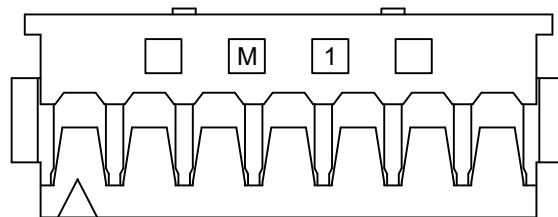

7Pin Shape

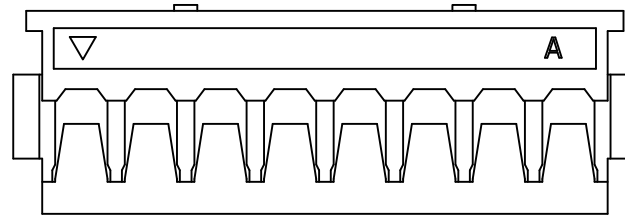

8~10Pin Shape

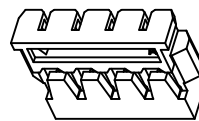
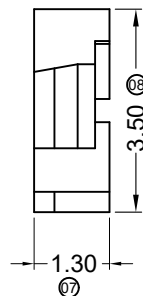
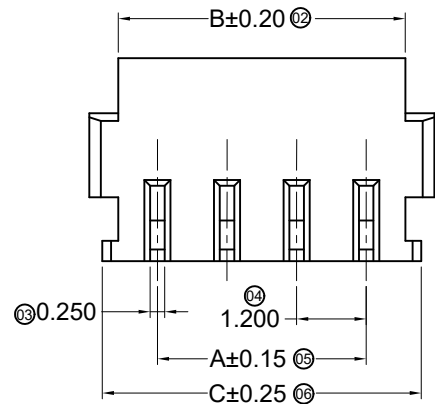
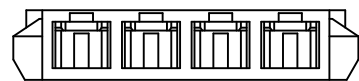

3D View

■ Specifications :

- Voltage rating: 50V AC / DC
- Current rating: 2A AC / DC
- Withstanding voltage: 500V AC/minute
- Temperature range: -25°C~+85°C
- Insulation resistance: ≥100MΩ
- Contact resistance: ≤20mΩ
- After environmental testing: ≤40mΩ

1224 H X- XX XX-LP XX-N

① ② ③ ④ ⑤ ⑥ ⑦ ⑧

- ① Series No.
- ② Category: H-HSG
- ③ Welding Board Angle: Blank-ordinary
- ④ Row No.-Pin No.: XX-02~10P
- ⑤ Special No.
- ⑥ Material: LP-LCP 94V-0
- ⑦ Color: Blank-Natural Color Black
- ⑧ Mark : N- No Mark

Poles	Dimensions(mm)		
	A	B	C
2	1.20	2.60	3.10
3	2.40	3.80	4.30
4	3.60	5.00	5.50
5	4.80	6.20	6.70
6	6.00	7.40	7.90
7	7.20	8.60	9.10
8	8.40	9.80	10.30
9	9.60	11.00	11.50
10	10.80	12.20	12.70

1224H-XX-LP-N	LCP UL 94V-0 Halogen Free	1224T	1224W
PART NO	Material	Suitable ADZL Terminal	Suitable ADZL Wafer

DATE	OLD REV	NEW REV	ECN	DESCRIPTION	CHECK	APPROVAL

GENERAL TOLERANCE
 .X ±0.30
 .XX ±0.20
 .XXX ±0.10



 东莞市思量连接器有限公司
 DONGGUAN ADZL CONNECTORS CO.,LTD.

APPROVAL	CHECK	DRAWN	DATA
Ken	Zhao Hong	Allen	2024/06/26

PART NO. 1224H-XX-LP-N			
TITLE 1.20 mm Crimp Style Connectors			
UNIT MM	SCALE 1:1	NUMBER	REV

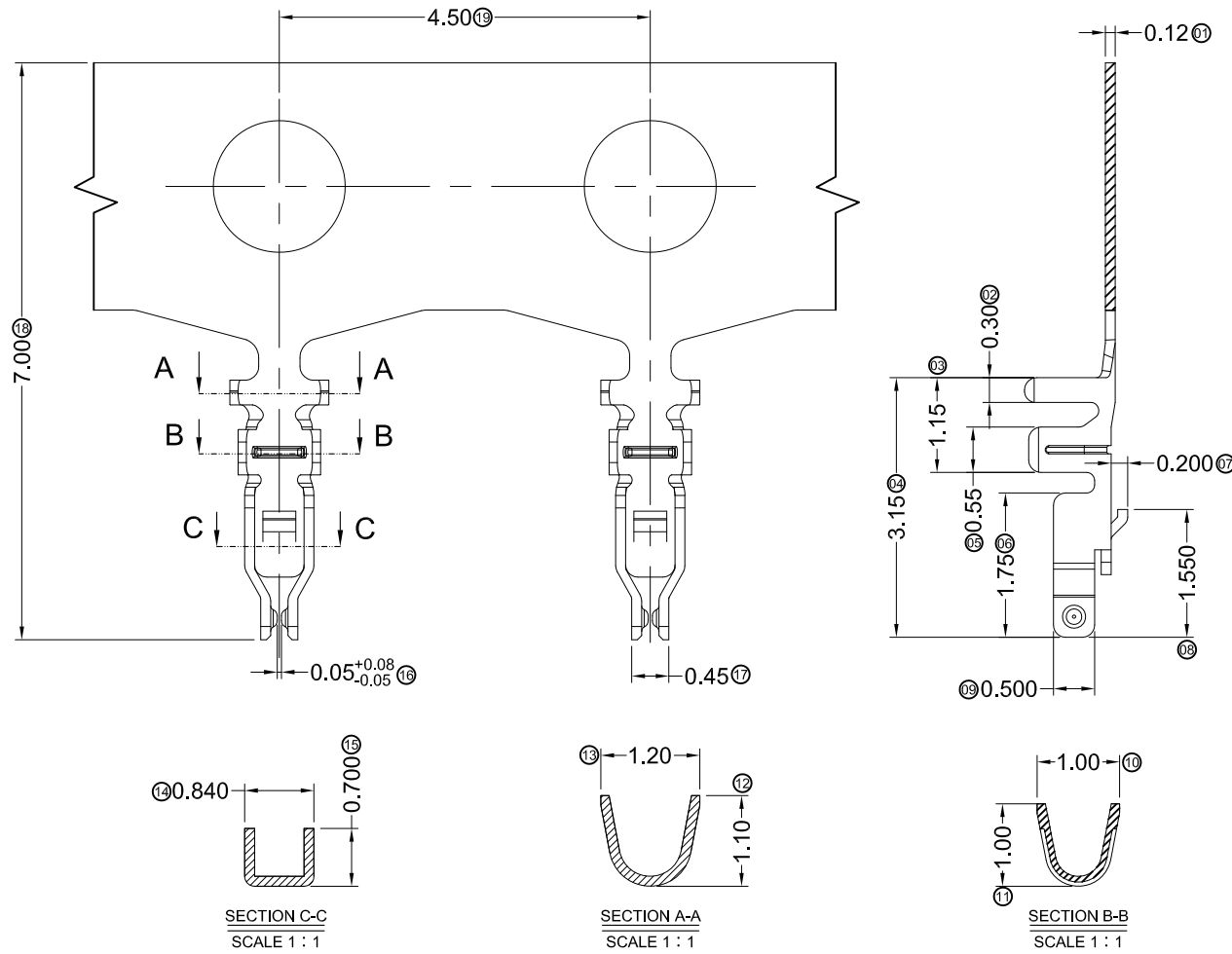

■ Specifications :

- Voltage rating: 50V AC / DC
- Current rating: 2A AC / DC
- Withstanding voltage: 500V AC/minute
- Temperature range: -25°C~+85°C
- Insulation resistance: ≥100MΩ
- Contact resistance: ≤20mΩ
- After environmental testing: ≤40mΩ

1224 T X-P V01 X

① ② ③ ④ ⑤ ⑥

- ① Series Number
- ② Category: T-terminal
- ③ Shape: Blank-ordinary
- ④ Material: P-Phosphor bronze
- ⑤ Plating style: V01- All Gold Flash
- ⑥ Plating method: Blank-Stamping before plating

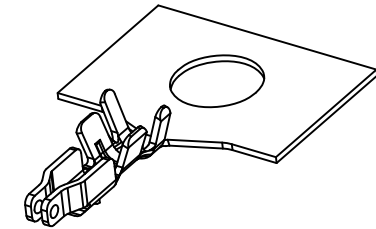

1224T-PV01	Phosphor Bronze	AWG#28-30	0.70mm (Max.)	Stamping Before Pating:30u" Ni;Whole Gold :Gold Flash	1224H
PART NO	Material	Wire Range	Insulation O.D.	Finish	Used In ADZL Housing

							GENERAL TOLERANCE .X ±0.30 .XX ±0.20 .XXX ±0.10				PART NO. 1224T-PV01 TITLE 1.20mm Crimp Style Connectors				
							APPROVAL CHECK DRAWN DATA Ken Zhao Hong Allen 2016/12/25				UNIT MM SCALE 1:1 NUMBER 8 REV				
DATE	OLD REV	NEW REV	ECN	DESCRIPTION	CHECK	APPROVAL	PROJECT	Ken	Zhao Hong	Allen	2016/12/25	UNIT	SCALE	NUMBER	REV



东莞市思量连接器有限公司
DONGGUAN ADZL CONNECTORS CO.,LTD.